



Review

6G Opportunities Arising from Internet of Things Use Cases: A Review Paper

Basel Barakat ^{1,*}, Ahmad Taha ^{2,*}, Ryan Samson ¹, Aiste Steponenaite ³, Shuja Ansari ², Patrick M. Langdon ¹, Ian J. Wassell ⁴, Qammer H. Abbasi ², Muhammad Ali Imran ² and Simeon Keates ⁵

¹ School of Engineering and the Built Environment, Edinburgh Napier University, 10 Colinton Road, Edinburgh EH10 5DT, UK; ryan.samson@napier.ac.uk (R.S.); P.Langdon@napier.ac.uk (P.M.L.)

² James Watt School of Engineering, College of Science and Engineering, University of Glasgow, Glasgow G12 8QQ, UK; Shuja.Ansari@glasgow.ac.uk (S.A.); qammer.abbasi@glasgow.ac.uk (Q.H.A.); muhammad.imran@glasgow.ac.uk (M.A.I.)

³ Medway School of Pharmacy, University of Kent, Anson Building, Central Avenue, Chatham ME4 4TB, UK; a.steponenaite@kent.ac.uk

⁴ Computer Laboratory, William Gates Building, 15 JJ Thomson Ave, Cambridge CB3 0FD, UK; ijjw24@cam.ac.uk

⁵ University of Chichester, Chichester PO169 6PE, UK; s.keates@chi.ac.uk

* Correspondence: b.barakat@napier.ac.uk (B.B.); ahmad.taha@glasgow.ac.uk (A.T.)

† These authors contributed equally to this work.



Citation: Barakat, B.; Taha, A.; Samson, R.; Steponenaite, A.; Ansari, S.; Langdon, P.M.; Wassell, I.J.; Abbasi, Q.H.; Imran, M.A.; Keates, S. 6G Opportunities Arising from Internet of Things Use Cases: A Review Paper. *Future Internet* **2021**, *13*, 159. <https://doi.org/10.3390/fi13060159>

Academic Editor: Georgios Kambourakis

Received: 21 May 2021
Accepted: 12 June 2021
Published: 18 June 2021

Publisher's Note: MDPI stays neutral with regard to jurisdictional claims in published maps and institutional affiliations.



Copyright: © 2021 by the authors. Licensee MDPI, Basel, Switzerland. This article is an open access article distributed under the terms and conditions of the Creative Commons Attribution (CC BY) license (<https://creativecommons.org/licenses/by/4.0/>).

Abstract: The race for the 6th generation of wireless networks (6G) has begun. Researchers around the world have started to explore the best solutions for the challenges that the previous generations have experienced. To provide the readers with a clear map of the current developments, several review papers shared their vision and critically evaluated the state of the art. However, most of the work is based on general observations and the big picture vision, and lack the practical implementation challenges of the Internet of Things (IoT) use cases. This paper takes a novel approach in the review, as we present a sample of IoT use cases that are representative of a wide variety of its implementations. The chosen use cases are from the most research-active sectors that can benefit from 6G and its enabling technologies. These sectors are healthcare, smart grid, transport, and Industry 4.0. Additionally, we identified some of the practical challenges and the lessons learned in the implementation of these use cases. The review highlights the cases' main requirements and how they overlap with the key drivers for the future generation of wireless networks.

Keywords: wireless networks; 6G; Internet of Things (IoT); healthcare; transport; smart grid; Industry 4.0

1. Introduction

Future networks will serve a wide range of new technologies in both hardware and software. Examples of such technologies are high-resolution immersive multimedia over the internet, smart Internet of Things (IoT) devices, factory automation, and autonomous vehicles [1]. They are planned to be implemented by 2030, and so these technologies are expected to be able to satisfy the future requirements of our society. Hence, the ITU-T has published its perspective on the network of 2030, and beyond, in which it has identified the key drivers for the future networks as shown in Figure 1.

The first driver is the high fidelity holographic society, which refers to the applications that have simultaneous and interactive communication. Holographic telepresence is an example of holographic-type communications (HTC) where remote participants are projected into a location, as holographic presences, to render local users into the remote location, for remote troubleshooting. For HTC to become reality, it requires the transmission of an extraordinary amount of data. Unlike video, it does not only depend on the colour depth, resolution, and frame rate, but it also requires a much higher volume of data. In particular,

HTC needs three extra “Degrees of Freedom”—tilt, angle, and position of the observer relative to the hologram—which require multiple viewpoints to get the full representation [2]. Communications in the future might also include applications that involve not only video and audio, but touch as well, such as the tactile internet [3,4]. However, why stop there? What about the other senses, such as smell and taste? Indeed, to create fully immersive experiences, it is necessary to include several senses in our communication.

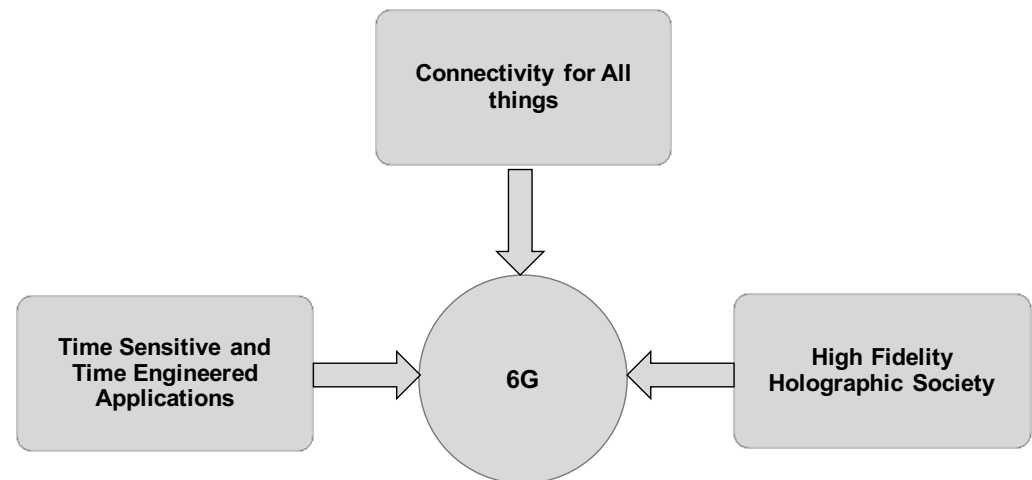

Figure 1. Key drivers for the 6th generation of wireless networks [1,2].

The second driver is the massive number of connected devices, referred to as “Connectivity for All Things”. IoT is the main reason for predicting exponentially increasing numbers of connected devices. The IoT can be defined as the network connecting billions of machines. The IoT communication occurs between machines or from the machine to the network with little to no human intervention [5,6]. IoT has great potential, as it benefits a wide range of sectors, including healthcare (such as the two use cases in Section 3) [7], smart grids (as discussed in Section 4) [8], transport systems (such as the use case in Section 5) [9], and manufacturing as shown in Section 6. It is forecasted that by 2025, there will be more than 75 billion IoT devices [10]. Providing reliable connectivity for this massive number of devices and the produced data by those devices is one of the most challenging aspects for network operators [11]. Although IoT was one of the driving forces for 5G, as it was a new paradigm with a significantly different set of requirements [6], it is expected to still pose a considerable challenge, as serving the forecasted IoT devices might be inordinate.

The last driver is related to the time-sensitive applications, as these are becoming more important with the new IoT applications, such as industrial automation, and autonomous systems. The time-factor becomes even more significant where humans are not the main generator/user of the data. That is why time-sensitive communication will be of prominent importance for future networks.

In this paper, a novel approach for a review is sought, where the focus is not on the overview and the envisaged use cases for 6G, but rather on how the challenges and limitations faced by previously implemented use cases can be addressed by 6G and its enabling technologies. The main aim here is to shed light on specific challenges within each of the presented sectors to highlight the opportunities offered by 6G. However, it is also to benefit the wider research community when attempting to conceptualise and design similar systems in the same domains or others by outlining where the current technology stands. Several published studies that mainly focus on the overview and the recent technological advancements [2,12–14], are already out there. However, we present some of the state-of-the-art IoT use cases that the authors previously contributed to and that are relevant to the current market trends. Although the presented IoT use cases are a small sample of the current IoT implementations, they are chosen from four sectors where the IoT plays a key role, and they represent a wide range of applications that 6G would service.

Moreover, these cases are still open for research and development, thus their capabilities and requirements can still be further advanced.

The remainder of the paper is structured as follows. Section 2 presents the approach used in the review and also highlights the used use cases. Section 3 presents the IoT use cases in the health care sector. Section 4 presents the use case in the smart grid, showing the implemented energy monitoring in a hospital. The transport use case is presented in section 5. The final sector, i.e., Industry 4.0, is presented in section 6. Section 7 presents the summary of the use cases, highlighting the challenges and the opportunities for the 6G. Section 8 summarises and concludes the paper.

2. Methodology

Several studies in the literature discuss the envisaged use cases that can best utilise the potential opportunities and services covered by 6G. This includes holographic telepresence [2,12,15], remote healthcare (telemedicine) [2,12,13,15,16], smart cities and environments [12], autonomous transport systems [12,17], remote learning [2], the brain–computer interface [18], and the list goes on.

To help identify the value of 6G key drivers to end-users, we examined if the envisioned potential of 6G would assist with current or future communication challenges in their sector. This approach was adopted to allow a practical insight into the potential of 6G throughout the different sectors. This unique approach aims to (1) create awareness of the potential of 6G technology and (2) relate the capabilities of 6G key drivers to real-life scenarios via use cases. The use case sectors were chosen based on their active state of development and implementation of IoT and/or mobile communication technology.

In the following sections, a series of use cases that utilise IoT and/or mobile communication technology are presented (as shown in Figure 2). Each subsection discusses the application, the technical specification and requirements, the results (where applicable), the challenges that are faced by the implementation of the use case and their potential solution in the context of 6G and its enabling technologies.

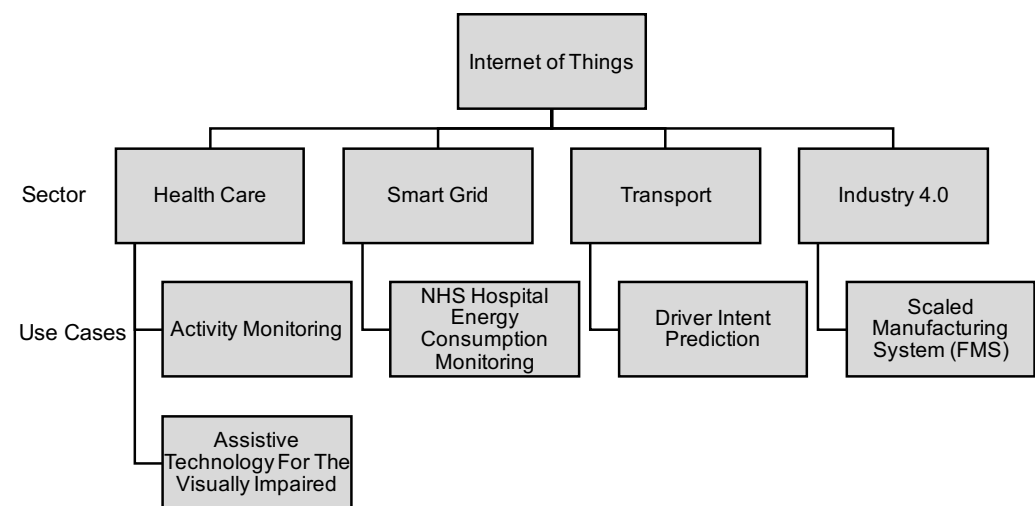

Figure 2. Use cases presented in this paper, showing the sectors and the use cases.

3. Healthcare

The ageing population challenge is an issue that should not be taken lightly. Various emerging studies predict nearly a two-fold increase in the population aged 65 and above in the next 40 to 50 years [19,20]. This has driven the need to incorporate technology and intelligent systems in our daily lives for healthcare monitoring as well as daily life support.

For years now, the IoT has played a vital role in relieving the pressure on healthcare professionals [21] through preventive and in-home care approach as opposed to traditional reactive and hospital-centred ones [22]. With the increased ageing population, epidemics

and pandemics, such as COVID-19, and the increased number of chronically ill patients [23], IoT for healthcare is at its highest demand. However, this increased demand raises the question—can the current technology keep up with it? The answer to this question is believed to lie in the 6th generation of mobile communication networks and its enabling technologies [23].

To highlight the potential role of 6G in healthcare, the authors in this section present two use cases that utilise different aspects of wireless communication technology. Each use case presents a futuristic vision of utilising new technology and the IoT to improve people's living standards. The first discusses the use of radio frequency (RF) sensing for non-invasive activity monitoring, and the second offers aid to people with visual impairment. The challenges and limitations of each use case are discussed towards the end of each subsection together with the envisaged role of 6G to fill the gap.

3.1. Human Activity Monitoring

3.1.1. Introduction

Recent years have shown an increased interest in the detection of human activity in both indoor and outdoor environments, such as healthcare [24–27], search and rescue through localisation and tracking [28–31], intrusion detection, and others. Existing techniques for human activity detection rely on ambient sensors, wearables and cameras that require, primarily, onerous deployment overheads. Moreover, they can raise concerns regarding privacy, including physical invasion of the environment. Researchers are continuously developing non-invasive, easily deployable, and privacy-preserving systems for detecting large-scale body movement, using two or more radio frequency (RF) transceivers as shown in Figure 3. This is motivated from the early use of radars to determine the distance, angle and/or velocity of an object, using radio waves. This principle is widely used by the military to detect and identify threats, such as drug smuggling, terrorist attacks, espionage, etc. [32]. The advancements in signal processing techniques have made radar detection and identification more robust while opening this field for further use cases, such as human activity classification. A moving target relative to a radar sensor induces a frequency shift in the echo as a result of the well-known Doppler effect. The distinctive characteristics of the observed micro-Doppler effect of an object or a process is called the micro-Doppler signature. Ultimately, a unique micro-Doppler signature for walking and running is the periodic motion of arms and legs, producing sidebands for the main Doppler frequency used for the detection and classification of the respective activity [33].

Since future 6G mobile networks are expected to thrive on even denser RF environments than the current 5G systems, here, we present a case study on human activity detection [34], using ambient RF waves [35,36]. The non-invasive and contactless human activity detection based on channel state information (CSI) utilising Wi-Fi devices has been studied extensively to detect daily living routines [37,38]. This includes the use of off-the-shelf wireless devices and network interface cards operating at 2.4 GHz to extract CSI information, depicting movement and activity. Similarly, other studies used radar-based systems to track occupancy through the use of frequency modulated continuous-wave (FMCW) and orthogonal frequency division multiplexing (OFDM) techniques [39].

The case study to be presented differs from those previously presented in the literature since the earlier work used off-the-shelf wireless devices that present numerous technical limitations. For instance, the Wi-Fi transmitter sends 56 subcarriers; however, a regular off-the-shelf NIC only reports 30 subcarriers, losing nearly 46% of the information [40]. Additionally, the transmitter power is not flexible and does not change according to a particular human activity. The presence of random noise also impairs the phase information retrieved through these small wireless devices [19]. In this case study, software-defined radios, specifically, universal software radio peripherals (USRPs), are used to transmit and receive N number of OFDM subcarriers, as compared to earlier work, where only a limited number of subcarriers were available. The system developed for this use case also allowed modification to the transceiver's power level and its operating frequency.

Moreover, it enabled the use of custom-designed antennas and more control on the number of subcarriers employed in real-time. The case study shows that the results obtained using USRP based wireless sensing for daily living activities are more accurate than those, owing to off-the-shelf wireless devices.

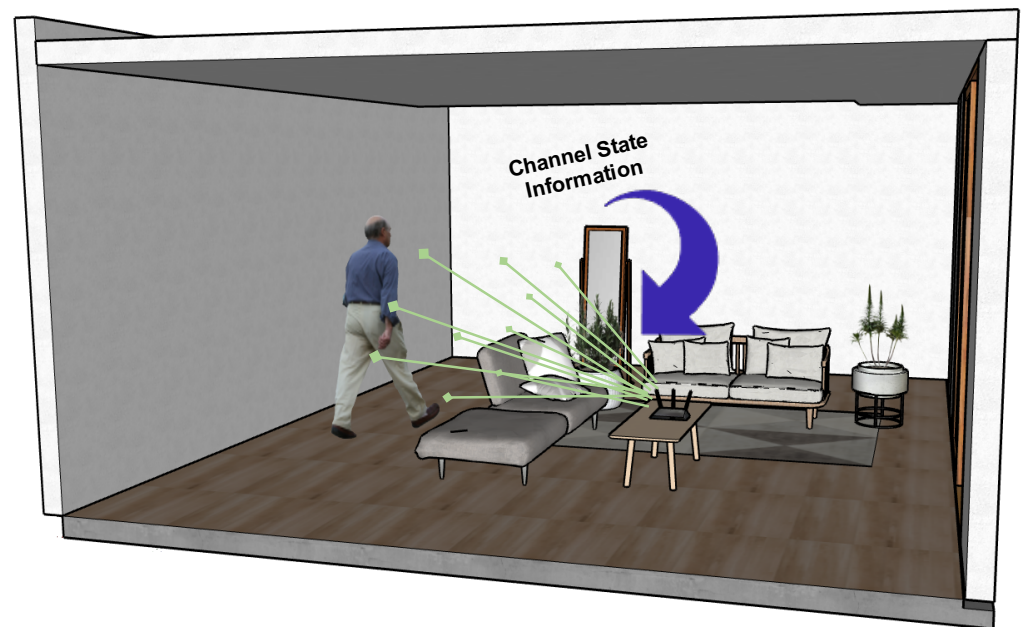

Figure 3. Activity monitoring using Ambient RF signals.

3.1.2. Human Activity Monitoring Using RF Signals

Referring to Figure 4, the OFDM transmitter model transmits multiple OFDM subcarriers, implemented using MATLAB/Simulink. The data generated are transmitted through the USRP, using an omnidirectional antenna operating in the frequency range from 2.4 to 2.5 GHz and from 4.9 to 5.9 GHz with 3 dB gain. The key advantage observed in using these omnidirectional antennas is that they can detect human activities performed in both line-of-sight and non-line-of-sight locations.

The experiment carried out in this use case was conducted in the James Watt Building South at the University of Glasgow where volunteers from different age groups participated. The motive behind the study was to build a foundation and develop a prototype of a system that can continuously monitor in-home daily activities for elderly people. The trials were performed in a controlled laboratory environment, where each individual was asked to perform various activities including (a) walking, (b) sitting on a chair, (c) standing from a chair, (d) exercising and (e) bending down to emulate the picking up of an object laying on the ground. All activities were repeated 10 times and the test was performed in a $7 \times 8 \text{ m}^2$ room, consisting of typical office furniture, such as tables and chairs.

The K-nearest neighbour (KNN) algorithm was used for the classification of five activities. Through a 10-fold cross-validation, the algorithm provided the optimal results, leaving one sample out for validation. In the experiment, 755,630 samples were processed for all activities. For the exercising activity, a total of 270,089 samples were correctly classified with 24,423 samples misclassified into other classes. A total of 13,337 out of the 24,423 misclassified samples were recognised as the activity “Picking up an Object”, 5074 samples as “Sitting Down”, 2577 samples as “Standing up” and 3435 samples as “Walking”. The overall recorded accuracy of the KNN classifier in this experiment was 89.73%. Other classification algorithms were compared to the KNN classifier. For instance, the Decision Tree (DT) classifier recorded an accuracy of 81.20%. Other tested algorithms included the discriminant analysis and Naïve Bayes, which had poor performance compared to both

the KNN and the DT, with an accuracy of 49.21% for the discriminant analysis and 23.28% for Naïve Bayes.

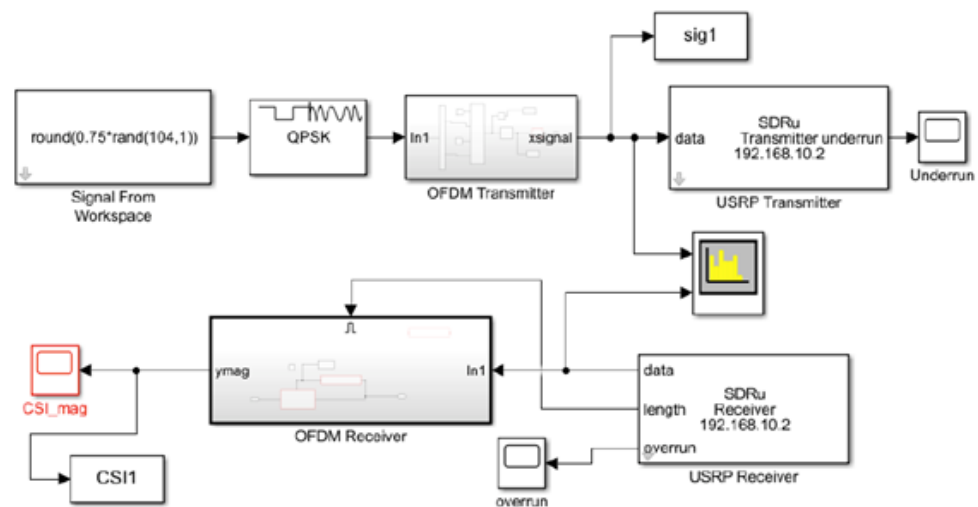

Figure 4. Simplified orthogonal frequency division multiplexing Simulink model for experiments [34].

3.1.3. Challenges and Future Directions

This case study on activity monitoring using dense ambient RF waves brings up a potential use case for future 6G mobile networks. Intelligent reflecting surface technology [41] being proposed for 6G are also great contenders for indoor activity monitoring [42]. By having these activity monitoring modules inherently integrated into the 6G radio antennas, this use case falls under two of the three key drivers for 6G, especially (i) high-fidelity holographic society, and (ii) time-sensitive and time-engineered applications. The ubiquity of 6G means that this approach can address a large number of applications. The practical implementation of such use cases adds a certain complexity to the radio planning stage, where in addition to the coverage footprint, the monitoring area and its environmental complexities also need to be taken into account. At this stage, this application is mainly proposed for healthcare settings. However, with large scale and ubiquitous penetration of human activity detection, this use case can play its role in energy usage monitoring, search and rescue missions, physical security of premises, Industry 4.0 applications and many other sectors.

3.2. Assistive Technologies for the Visually Impaired

3.2.1. Introduction

Improving healthcare and living conditions has led to increased life expectancy that for females went from 60 years, if you were born in early 1900s, to 94 years for people born in 2016 [43]. Even though some elderly people are lucky to age healthily, age associated diseases are very common across the world. According to the World Health Organisation estimate, 2.2 billion people worldwide are living with visual impairment and over 50 years old are affected the most [44]. With increased life expectancy, there will also be an increasing number of people with age associated diseases, such as visual impairment arising from age-related macular degeneration, cataracts or glaucoma. In the U.K., 3% of the population (almost 2 million people) live with sight loss, and this is expected to rise to 4 million by 2050 [45]. Together with increasing life expectancy, the overall number of elderly will increase too, increasing the economic burden when managing age-associated diseases [46].

The annual costs for visually impaired persons were estimated to be EUR 15,180 million in the U.K., EUR 9214 million in Germany, EUR 12,069 million in Italy, and EUR 10,749 million in France. In the U.K., the government spent GBP 410 million on devices and modifications for visually impaired people in 2013 [45]. The most common are mobility and communication devices, optical aids and home modifications [47]. Because this equipment

is highly specialised, it is usually costly and may not be easily accessible for everyone in need [48]. Therefore, in this use case, we propose a simple, cost-effective, easy and reliable tool to help visually impaired people locate their items [49].

3.2.2. Real-Time Objects Detection Framework

The system consists of two key elements: a smartphone and a personal computer (PC). By using machine learning, the framework is trained to recognise 82 objects from the common objects in context (COCO) dataset [50], such as a fork, knife, bowl, banana, and apple. Users verbally communicate with the smartphone, indicating the object that they are looking for and the smartphone transmits the object information to the PC via the network. The PC initiates the receiving video from the smartphone and while the user is moving the device around to help to locate the wanted object, the computer reads each frame, trying to identify the object that the user is looking for. Once detected by the ‘You Only Look Once’ (YOLO V3) [51] algorithm running on the PC, a verbal message is sent to the smartphone, saying: “found the object of interest”, an illustration of the system shown in Figure 5.

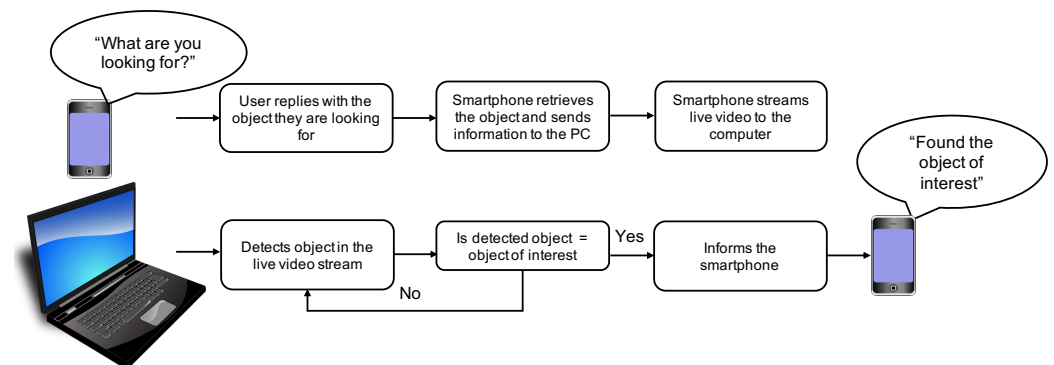

Figure 5. The framework flow of smartphone and computer tasks [49].

The efficiency of the framework here depends on the machine-learning algorithm performance. With the recent developments in computer vision and the amount of data freely available for developers, the accuracy of the detection is continuously improving. However, the challenge that we faced when implementing this framework was the computational requirement of these systems. We note that most of the users might not have powerful graphical processing units (GPU), which are necessary for optimising the speed of detecting objects in the streamed video. Therefore, we optimised its performance by controlling the number of frames per second so that it is compatible with the speed of detection.

Initially, we modelled the framework as a queue: where the video frames per second (fps) represent inter-arrival rates of the queue, whereas time taken to detect the object is the service time. Using this model, we derived an expression for the optimal number of fps needed to achieve the best real-time performance. The optimisation was based on the information freshness evaluation metrics. In particular, we used the information peak age (PA) as a metric [52–55], which is the maximum time taken since the generation of the preceding piece of information.

The PA is determined by the inter-arrival time (fps in this case), and the service time (which is the time of detection). The PA for different inter-arrival and service times is presented in Figure 6. The inter-arrival time can be controlled by the smartphone, while the service time depends on the PC processing unit. We started with measuring the service time—how long it takes for the PC to recognise the objects from a low-resolution video input (160×120)—and found that it takes 0.31 ± 0.06 s (Figure 7a). The service time distribution was assessed, using the Fitter package [56] and we saw that most frames were processed within 0.30–0.31 s (Figure 7b).

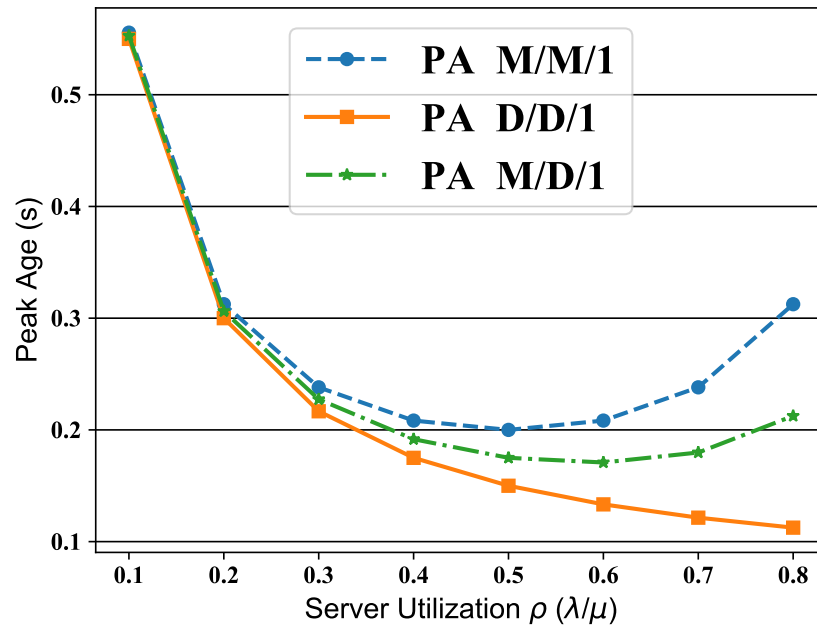

Figure 6. The PA value with respect to the server utilisation, that is, the inter-arrival rate (λ) divided by the service rate (μ). The achieved value is calculated for various queues. The queues differ in their inter-arrival time and service time distribution. The presented queues are M/M/1, which is a queue with both the inter-arrival rate and the service rate, following an exponential distribution. The D/D/1 queue has both rates to be deterministic and the M/D/1 queue has an exponential inter-arrival time and deterministic service time [49].

As shown in Figure 7, the service time has some variability but it is insignificant. Thus, we modelled the framework as an M/D/1 queue [57]. We assumed the inter-arrival rate (video frames per second) and delay time, caused by the network, to follow an exponential distribution. Using the PA expression, we optimised the fps to achieve a minimum PA of 130 ms, whereas the PA before optimisation was 1402 ms.

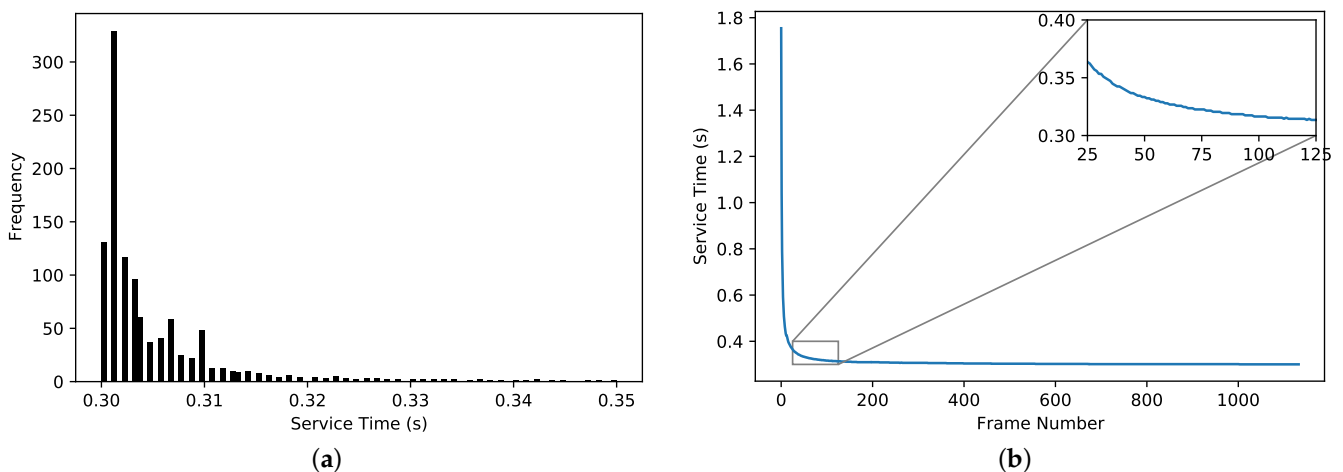

Figure 7. Measurement of the achieved service time—time to detect objects in a frame. (a) The relationship frame number and the time it takes (service time) to recognise objects in each frame. (b) Histogram of the achieved service time. Most frames were processed within 0.30–0.31 s time bracket.

3.2.3. Challenges and Future Directions

Despite being efficient enough, the proposed real-time object detection application is far from perfect. It is a local system that is trained to identify only 82 objects. To have a larger number of objects, the machine-learning model needs a significant amount of processing power, thus the next step is to move the detection algorithm to a powerful, cloud-based server. However, the challenge then is the connectivity between the smartphone and the sever, especially since the network delay significantly increases [55,58].

The delay affecting the live video affects the performance of the framework and thus makes it harder for a visually impaired person to use it. Thus, for this use case to be efficiently implemented, it requires the network to handle a high-resolution video in a timely manner, which is especially challenging since the streamed video requires a significant amount of data to be transmitted in high quality. Additionally, to have the framework work efficiently, it should work in real time, thus we require the network to have very low latency. Lastly, as the goal is to have the users be able to use the system independently, it requires the network coverage to be large enough to provide the service in most areas.

4. Smart Grid

4.1. Introduction

The race against climate change has been a great challenge for years and the U.K. government has taken serious steps towards carbon neutrality. One of the primary focuses of the U.K. government, after becoming the first of the major economic leaders in the world to pass laws that put a stop to its contributions to climate change, by 2050 [59] is to expand the use of smart utility monitoring and improve energy-conscious behaviour.

Extensive research has gone into promoting energy-conscious behaviour by providing feedback on energy consumption through various utility monitoring techniques [60], in university residential buildings [61,62], private homes [63–65] and hospitals [66]. The focus is on how to utilise different forms of smart metering to promote energy-conscious behaviour through behavioural change interventions, which have shown the potential to provide immediate energy savings of up to 12% [67]. Nevertheless, there is more to smart utility monitoring than raising occupants' awareness—it is also used as means of collecting high-resolution energy data [68] to build forecasting models [69,70]. Such models are useful for various reasons, including ensuring effective future energy supply, load management, and lastly energy management. This shows the great interest in high resolution energy data and the role it can play to reduce overall consumption in the building sector.

The use of wireless communication and the IoT is inevitable in order to reliably collect high resolution energy data to enable the development of energy-saving systems. The rollout of smart metering started in 2011 in the U.K. [71] with several research studies published since then, discussing IoT-based energy monitoring and management systems [72–76]. The idea of a smart metering system is to make automatically available information about energy consumption in a centralised database. On a commercial level, such information is used by energy suppliers for billing energy users and predicting future consumption to adjust monthly tariffs. On a research level, the collected data are of great value to initiatives, such as behavioural change interventions, demand response studies, load management, and so on.

The key performance indicators (KPIs) of an energy monitoring system can be subdivided into three branches (see Figure 8). The first is the resolution of the data, that is, how often data are captured, for example, daily, hourly, half-hourly (HH), or in real-time. The second branch covers the loads reflected by the data, that is, aggregate or individualised loads. Finally, the third branch is the data logging rate, that is, how quickly the data are made available to the beneficiaries.

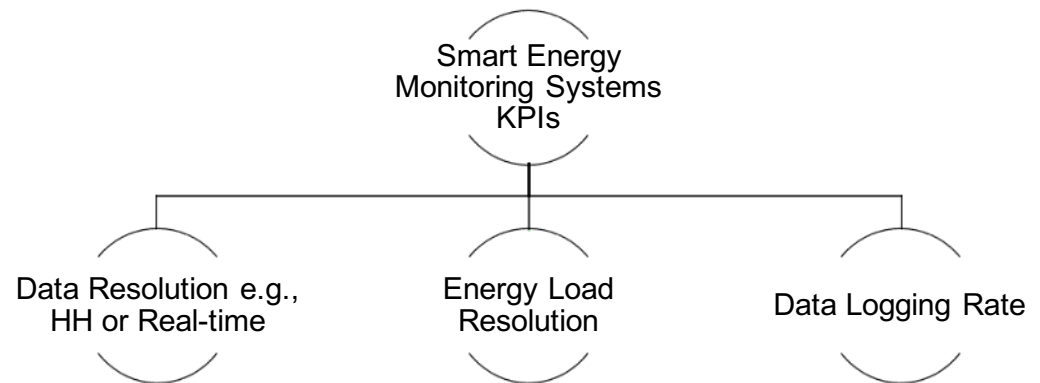

Figure 8. Key performance indicators identified for smart energy monitoring systems.

The three KPIs identified in Figure 8 have a vital role to play in evolving IoT-based energy monitoring systems for smart grids and smart cities. Each KPI is briefly elaborated upon below:

- **Energy Data Resolution:** The resolution is greatly dependant on the application and the use of such data. However, higher resolution data are greatly sought as they enable fine-grained monitoring of consumption and recognition of the transient spikes in power demand, which can be useful in energy modelling [77]. Moreover, the availability of real-time consumption can greatly support behavioural change interventions by performing time-series analysis of occupancy vs. consumption to identify where energy-conscious behaviour needs to be promoted.
- **Energy load resolution:** Another key feature in the collected data is the load resolution, that is, what the collected data reflect in terms of load. For instance, taking a university building as an example, data from the main cable reflect the aggregate electricity consumption in the whole building, and whilst this is useful information, on a top-level, researchers and end-users are more interested in much higher resolutions. Energy sensing at the main supplies can only give an indication of the behaviour and efficiency of energy usage by users and equipment. Therefore, it is crucial to see a higher resolution of energy sensing being performed within a building. For instance, this can be through sub-metering or by installing individual energy-sensing nodes at power sockets and individual distribution boards to get a sense of the actual activity being performed in every part of the building. Such an approach, if combined with AI, can serve many use cases in smart cities, such as occupancy monitoring, activity monitoring for the elderly, and of course, maintaining carbon-efficient operation within the building. However, with the current technologies, there are several challenges that are further highlighted in this section.
- **Data logging rate:** This is one of the most important parameters and KPIs in any communication system. The first two KPIs deal with the data collection by ensuring that meaningful data are being gathered. However, the instant availability and accessibility of these data is crucial for applications that are time critical. As briefly mentioned earlier, high resolution energy data can serve multiple applications, such as occupancy and activity monitoring, which consequently can help in cases such as emergency evacuation, hence the need for the instant logging of data and rapid processing to avoid catastrophic consequences resulting from any delays in data transmission.

Having introduced the KPIs of energy monitoring systems, it is crucial to see how this is applied in real-life, whilst highlighting the challenges and the opportunities for improvement. The following subsection presents a use case that aimed at promoting energy-conscious behaviour through the use of persuasive technology in the form of feedback on energy consumption in an NHS hospital in the U.K. [66]. The use case presented describes the developed system, technical specifications, achieved results, challenges and limitations. The latter points are then expanded upon to highlight how 6G can fill the gaps to yield

a more robust energy-saving system. Figure 9 shows the past and futuristic visions of energy-saving systems that address energy usage behaviour in the building sector.

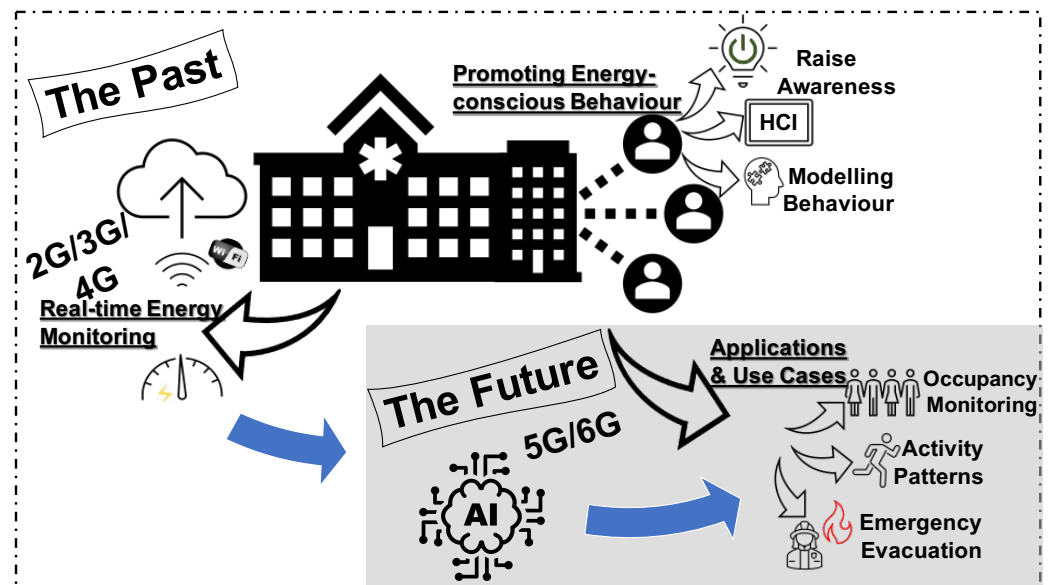

Figure 9. Smart utility monitoring for energy-saving systems—the past and the future.

4.2. Promoting Energy-Conscious Behaviour Using Persuasive Technology: A National Health Service (NHS) Use Case

This use case was an initiative aimed at utilising persuasive technology [78] to promote energy-conscious behaviour in a National Health Service (NHS) hospital, located in Medway towns, the United Kingdom. In [66], the authors present a socio-technical model that brings together a wireless electricity data logger (WEDL) and a human-computer interaction (HCI)-based dashboard to influence the behavioural change amongst members of staff working in hospital wards as depicted in the top right corner of Figure 9.

The reliability of the initiative taken in the NHS hospital to reduce energy consumption is heavily reliant on that of the WEDL, which utilises the General Packet Radio Service (GPRS) technology to communicate the electricity consumption data (see Figure 10a,b).

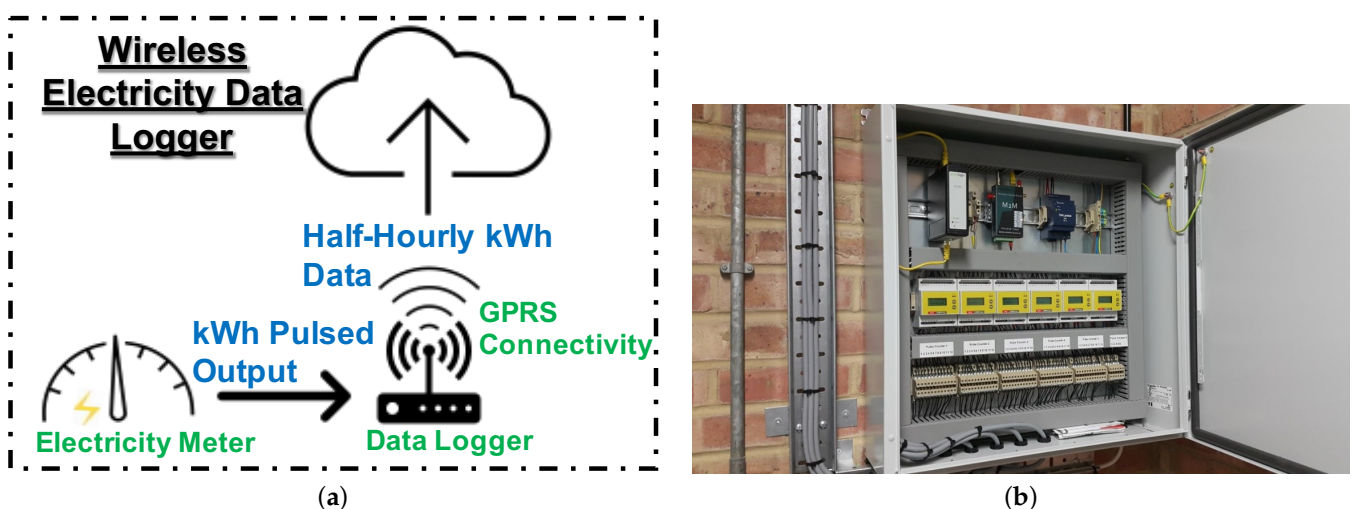

Figure 10. Smart electricity monitoring system installed in Medway NHS hospital. (a) Block diagram and data flow. (b) System installation.

Upon the introduction of the WEDL system, a five-month intervention was designed and carried out, which involved raising the energy users' awareness of their consumption in the workplace, using data generated by the WEDL. The intervention resulted in a 10.5% reduction in electricity consumption, despite a rise of 32.3% in the number of patients. The comparison was made between the baseline data and the intervention data based on time of year analysis, meaning both sets of data were collected during the same months of the years 2018 (baseline—before the WEDL) and 2019 (intervention—after the WEDL) (see Figure 11).

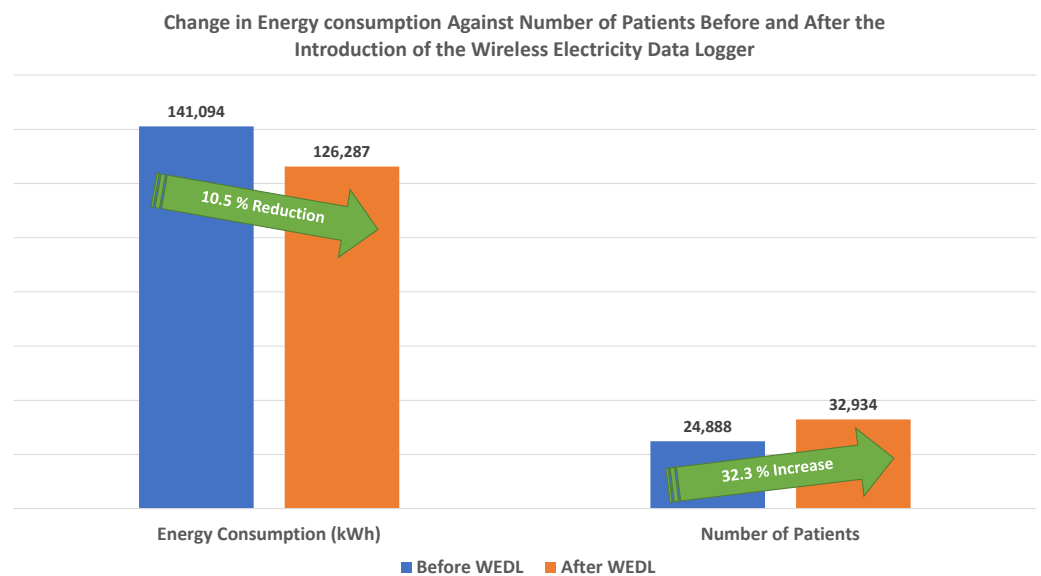

Figure 11. Energy consumption status in the NHS hospital, before and after the introduction of the wireless electricity data logger.

An evaluation of the WEDL, installed and trialled in the NHS, is performed based on the KPIs presented earlier in Figure 8. The evaluation aims at highlighting the potential improvement that could be made to smart utility monitoring-based energy saving systems with the introduction of 6G and its enabling technologies.

4.3. Challenges and Future Directions: An Evaluation of the Wireless Electricity Data Logger System

The KPIs, presented earlier in Figure 8, were used to evaluate the WEDL deployed in the Medway NHS hospital. Figure 12 shows a spectrum-like structure, which depicts the various technical specifications that a typical WEDL would have. The last column in Figure 12 is the ultimate solution towards real-time, intelligent, and fine-grained monitoring of energy consumption.

The four green-coloured and black-bordered blocks in Figure 12 represent the specifications of the WEDL installed and piloted in the Medway NHS hospital. As can be seen, the system did well in the data and energy-load resolutions with a near perfect score, as per the presented model. However, it was far behind in the third KPI, that is, the Data Logging Rates, as it relied on GPRS connectivity.

The advancements in the mobile generations and their enabling technologies over the past few years are making it feasible to enhance smart monitoring of energy consumption for contributions towards a carbon efficient world. For instance, the 4th generation of mobile networks are capable of significantly improving the performance of the WEDL by offering data rates of 100 Mbps and even 300 Mbps, with the latest release [79]. We note that 5G can even offer data rates of more than 1 Gbps [79]. However, to see the WEDL and similar smart energy monitoring systems in the far right of the spectrum, presented in Figure 12 and the envisaged futuristic form presented in Figure 9, it is crucial to start

thinking about the role of 6G. Nevertheless, there are some challenges and difficulties that might face the practical implementation of this use case on a wider scale. This includes the physical installation of the unlimited number of energy nodes to increase the resolution, which also means massive capacity demand and the need for increasing the spectrum bandwidth, implementing new modulation techniques, and others, to overcome this [80].

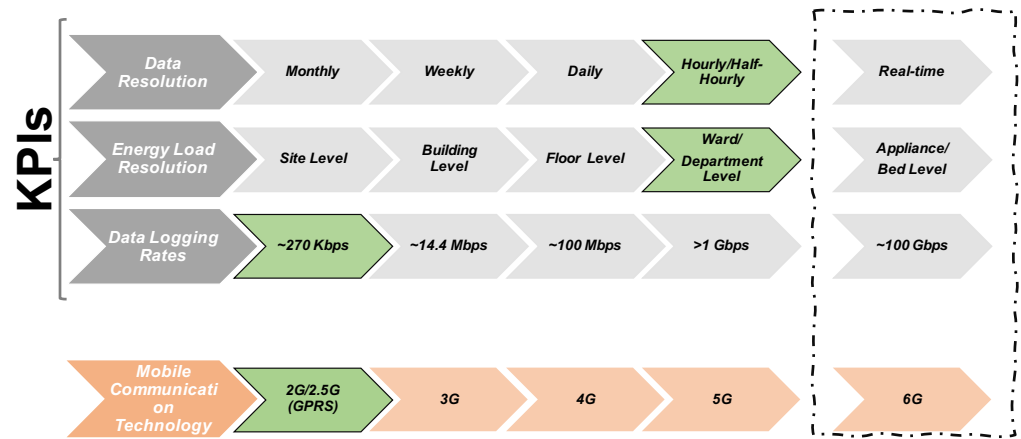

Figure 12. Evolution and evaluation of smart utility monitoring technology in the context of mobile generations technology.

The future of energy-saving systems combine intelligence, high resolution of data, unlimited numbers of connected energy-sensing nodes, high data rates, and low latency, all of which are what 6G is envisaging to bring to the table [2,18,81]. Artificial intelligence (AI) is expected to greatly empower 6G networks and extend several features that are not envisaged with 5G technology. With particular focus on Service Intelligence (SI), [81], 6G can greatly help with the management and organisation of the data collected from multiple energy nodes. Therefore, the authors are clear that the utilisation of 6G in energy-saving initiatives will enable the development of intelligent systems that are capable of making contributions to achieve carbon neutrality through, for example, brain-computer interface-based energy-saving systems [18], which can greatly help with promoting energy-conscious behaviour—a key focal point in the U.K. government’s plan towards the 2050 net zero carbon target. It can, therefore, be highlighted that 6G with particular focus on two of its three key drivers, that is, connectivity of all things and time sensitive applications can fill the gaps in current initiatives taken to monitor energy consumption.

5. Transport

5.1. Introduction

The transport sector plays a vital role in our everyday life. However, the increasing population and number of cars and road users in cities have worsened its problems, such as (i) traffic jams, (ii) accidents, (iii) pollution, (iv) fuel cost, (v) fuel scarcity, (vi) insurance costs, and (vii) others [82]. As a result, there is a wide range of improvements aimed at enhancing the sector productivity, safety, and carbon footprint. Researchers are continuously working on making every aspect of the transport system intelligent—starting from a smarter infrastructure, intelligent vehicles, and intelligent public transport as shown in Figure 13.

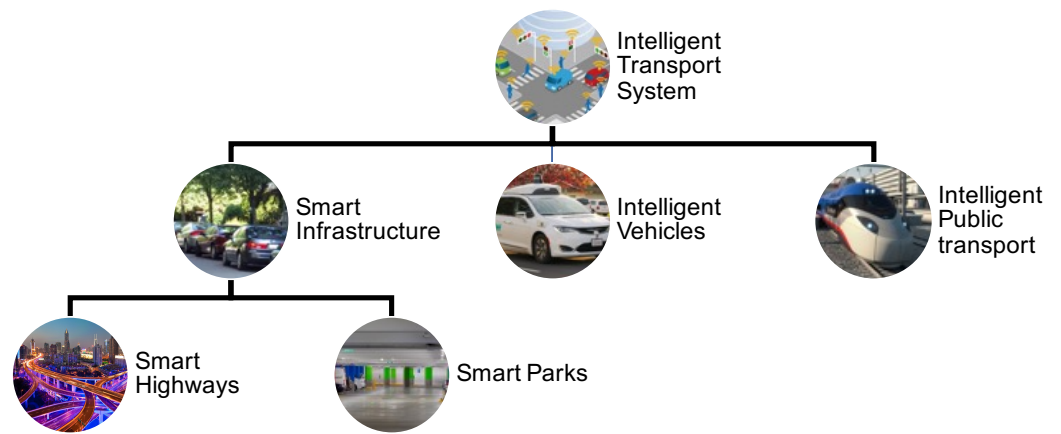

Figure 13. An overview of the intelligent transport systems, showing the main research areas, that is, smart infrastructure, intelligent vehicles, and intelligent public transport systems.

Several developments in the transport architecture have already been implemented worldwide, for example, wirelessly-controlled traffic signs, smart intersections, and violation detection [82]. Intelligent public transportation systems (IPTs) [83] utilise technologies to further their development and implementation. For example, real-time monitoring provides passengers’ with information about the state of the network, that is, traveller information systems (TIS). The advances in the state-of-the-art technologies also provide us with the ability to control transport systems through the integration of decision support systems (DSS).

Intelligent vehicles refer to a wide range of capabilities and technologies. A classification of vehicles based on their capabilities is proposed in [84,85] and shown in Figure 14. The first category is conventional vehicles that do not have any assisting technologies. The vehicles that contain some features to help the driver fall in the second category. The third category has vehicles that are able to observe the environment and help the driver in some functions, while if the vehicle has the ability to monitor the environment with high accuracy and perform the driving tasks, it falls in the fourth category. The fifth category has the highest degree of automation in which the vehicle can autonomously drive in all conditions.

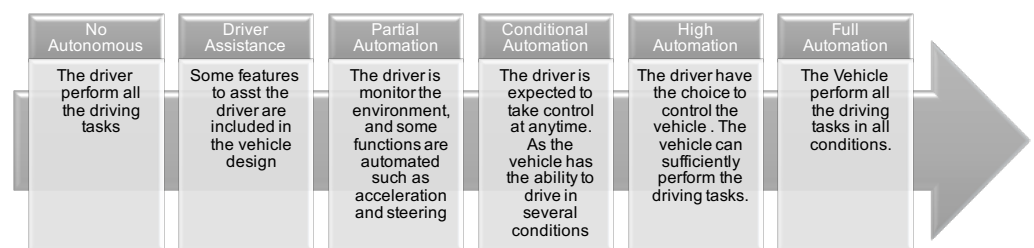

Figure 14. The classification of autonomous vehicles starting from the no automation to the highest automation category [84,85].

To reach full automation, there have been several advances into realising sufficiently connected vehicles [86–89], which is key to the success of autonomous driving as well as enhancing transportation efficiency and safety. This includes the connection between vehicles, and vehicle-to-cloud communications, imposing new requirements on in-vehicle systems and the supporting infrastructure [90–92].

5.2. Predicting the Intent to Return to a Vehicle

In this paper, we present a use case of driver assistance. Here, the vehicle can determine if and when the driver is returning, ideally aiming to find it out as early as possible

and before the start of a journey. Knowing the intent of the driver can help the vehicle to do the following:

1. Deliver a safer, personalised, and more pleasant driving experience by the timely adaptation of the car interior to prior learnt preferences or the driver profile (e.g., adjusting seats and pre-configuring the infotainment system, and adapting the human-machine interface (HMI), for example, warming/cooling the vehicle.);
2. Improve the security features by efficient activation of the key-fob scanner (e.g., for keyless entry or engine start) and exterior-facing vehicle sensors (e.g., cameras for driver recognition).

In this use case, we address the problem of establishing the driver's intent to return to the car and estimating the time of arrival from his/her available partial location trajectory, possibly in a connected vehicle environment (illustrated in Figure 15). This track can be provided by a dedicated user-to-vehicle positioning solution or the user's smartphone Global Navigation Satellite System (GNSS) service. The problem is tackled within a Bayesian object tracking framework [91]. Unlike typical data-driven methods [93], this case proposes a simple prediction solution with notably low training requirements. It utilises the incorporation of contextual information, such as the user's (learnt) patterns of behaviour, calendar events, location, time of day, etc. To ensure that the framework is flexible and generic, it encloses the variations in the user motion on his/her way to the vehicle by assuming a stochastic motion model. Using the continuous-time observation model with a random noise component, the framework can also treat irregularly spaced and imprecise user location measurements.

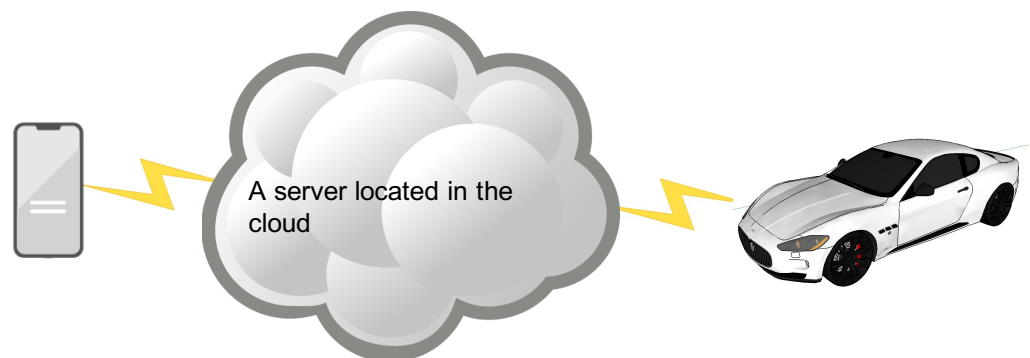

Figure 15. Smartphone-based implementation of the proposed solution. The instantaneous location of the smartphone is determined using the Global Navigation Satellite System (GNSS) service, and shared with the vehicle via a cloud service.

In this use case, a Bayesian Framework is used to calculate the probability that the driver is returning to the vehicle. In particular, it calculates the probability of two hypotheses: $(H_{0,n})$, which refers to user n returning to the vehicle and $(H_{1,n})$ which refers to the user not returning to the vehicle. The probability of $(H_{0,n})$ is determined using contextual information, such as time of the day and calendar. It also includes the user's motion model, using a stochastic differential equation. An android smartphone (assisted) GPS service collects the measurement of the instantaneous location at a rate of one per second (1 Hz).

The framework calculates the probabilities of the driver returning to the vehicle. The sequentially estimated probabilities are shown in Figure 16. Figure 16a shows the results when the user returns to the car, and Figure 16b exhibits the inference outcome when the user walks towards and then past the car. For the real-time system response for these two trajectories, please refer to the attached video (available at: <https://youtu.be/0wHG-HqByyI>, accessed on 4 May 2021). By looking at the "Probability of Returning to the Car" graphs, you can see that the proposed framework provides early, successful predictions in both scenarios.

In both scenarios, the probability of returning to the car is estimated by the framework to be significantly higher after 35 s, which can be considered to be early in the walking track.

For the second case, the inference module correctly predicts that the driver is returning to the vehicle up until the time instant $t = 125$ s. As the user walks past the vehicle, the framework adapts to the situation and quickly changes its predictions. Contextual information, such as time of day and calendar, can be employed to determine if the user is returning to the car, even if the motion behaviour is consistent with walking to the vehicle as shown in Figure 16b. The contextual information can be easily incorporated within the adopted Bayesian framework.

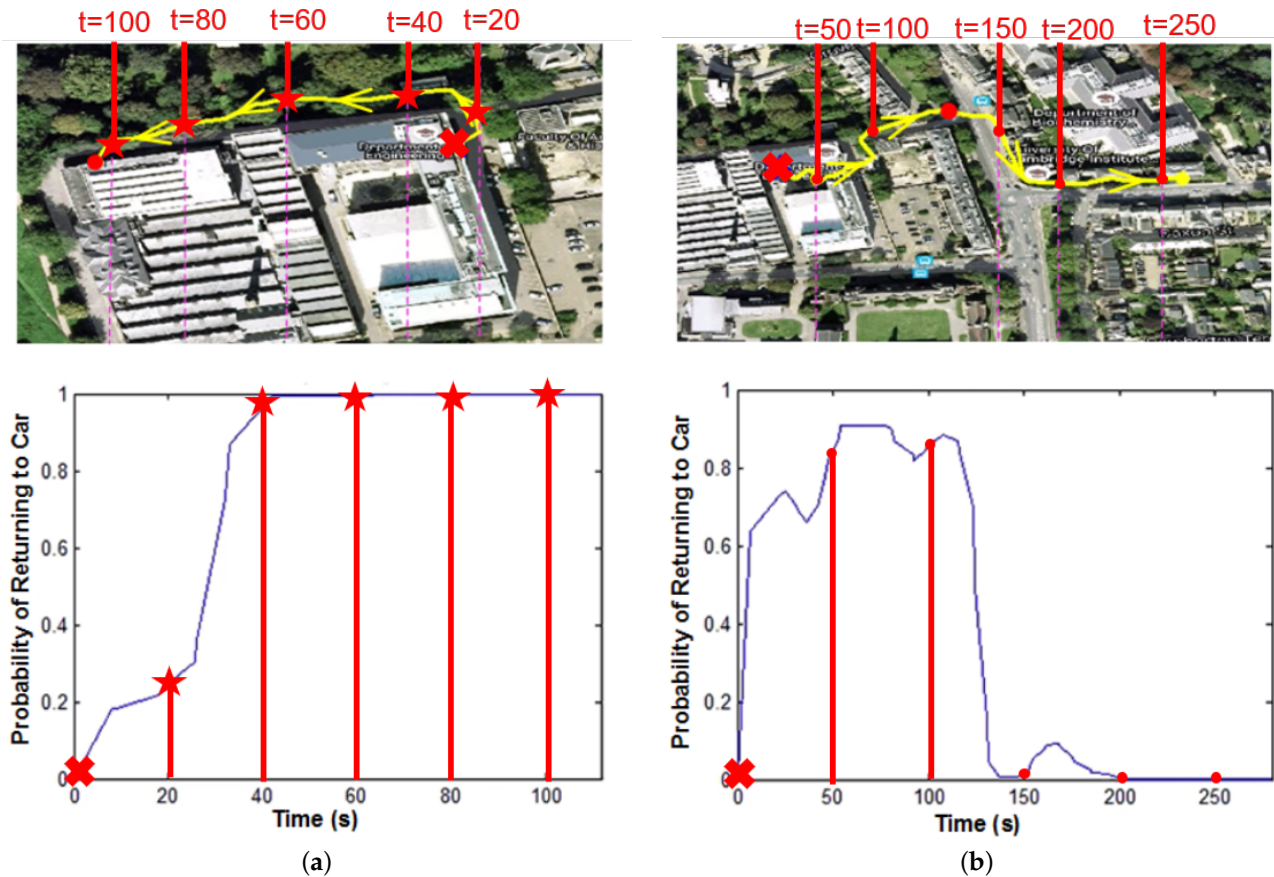

Figure 16. Inference results for the two scenarios, where the user walk back/past the vehicle, with respect to time in seconds. In box pictures, the car is marked as a red circle and the trajectory of the walked track is displayed in yellow. The direction of travel is indicated in the arrows. The red cross is the starting point and selected timestamps of the GPS trajectory are marked with stars. The graphs show the corresponding destination prediction as a function of time, that is, the probability that the user is returning to the vehicle. (a) First scenario where the driver returns to the car. (b) Second scenario where the driver walks past the car without returning to it.

5.3. Challenges and Future Directions

From this use case, we can observe that we are expecting a ubiquitous connection between the vehicle and the user. Additionally, we are expecting that the user position is communicated to the vehicle in real-time. Manufacturers adopting and implementing this framework would find these requirements challenging, especially since the vehicles might be in remote car parks.

This brings us to the key drivers for 6G, shown in Figure 1. This use case falls under two of the three key drivers, that is, (i) connectivity for all things, and (ii) time-sensitive applications. It can be argued that the information here is not very time-sensitive; however, for better performance, the frequency of transmitting the location should be increased. Although in this use case the vehicle is stationary, in future work, this vehicle can be moving, such as in the case of car sharing services. The aim then would be to have the vehicle

ready before it reaches the passenger. Having both the passenger and the vehicle moving adds an extra level of complexity. Therefore, both, the connectivity and the frequency of transmitting the locations must be reliable.

The position in this case study is determined, using the GNSS. However, to achieve full automation, we must use a more accurate positioning technology, hence the currently achieved few-meter accuracy is not sufficient to stir the vehicles. The 6G and its enablers, such as wider bandwidths, higher frequencies and massive antenna arrays, can achieve accurate positioning [94]. Sophisticated machine-learning algorithms can use the data to further improve the positioning accuracy and reliability. For instance, in [95], it was shown that we can achieve cm-level accuracy from a single-snapshot, using millimeter-wave frequencies and maximum likelihood estimation to achieve very high accuracy, despite using a single antenna receiver.

In general, vehicles have several computers on board, and their processing power (capacity) is already consumed with the current demand. To facilitate the demands of autonomous cars, it is necessary to determine the location of these calculations, as can be done in vehicles, the network edge, or the cloud. If we take the approach of offloading these calculations, it is necessary to have reliable communication with a very short round trip duration. Additionally, if in the future, vehicles communicate with each other to optimise the stirring, the complexity of this requirement will significantly increase.

6. Industry 4.0

6.1. Introduction

Increasing customer requirements with a demand for customised products applies pressure to manufacturing companies to increase flexibility within their production environment. Recent developments in industrial technology aim to assist with the increased flexibility requirement [96,97]. Industry 4.0 (I4.0) is the fourth major development of technology within the industry [98]. This revolution is perceived as the integration of two worlds—physical (robotics and automated machines) and virtual (AI, big data), utilising the Internet of Things (IoT)—to develop the concept of smart factories. Figure 17 presents the four major developments in the industry, detailing the major technology developments at each stage.

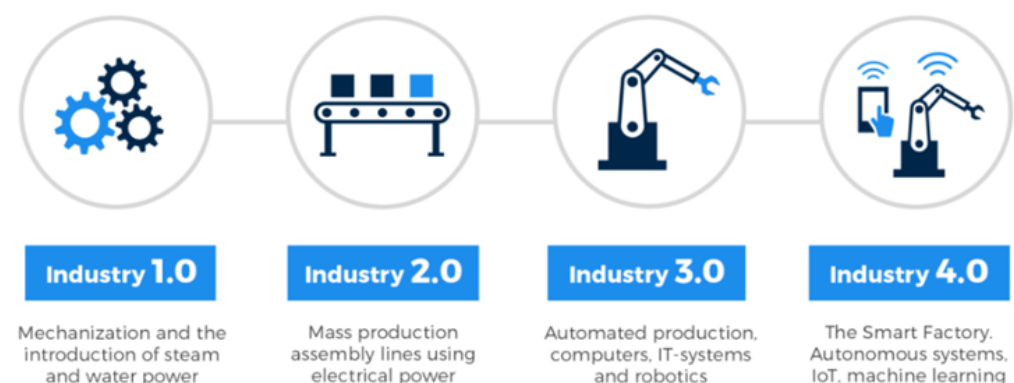

Figure 17. Industry Developments, 1st to 4th industrial revolution [99].

The literature presents many definitions for the fourth industrial revolution; however, the objective is the same throughout all definitions—to increase productivity and competitiveness in the industrial setting [100]. Many requirements of Industry 4.0 can be achieved by using existing technology and integrating this with increased level of connectivity to capture more information in a process for analysis in real time [101].

Increasing automation with Industry 4.0, enabling technologies, such as collaborative robotics, performance monitoring via digital platforms and remote control, can increase productivity by between 45% and 55% [102]. Some organisations, especially small and

medium enterprises (SMEs), choose traditional methods, such as pen and paper for data collection [103], creating room for error, leading to inaccuracies throughout the manufacturing process and, hence, reducing productivity. The enabling technology of I4.0 requires increased connection speed and reliability to record and publish production data, enabling employee's efforts to be directed towards important decision making as opposed to data gathering.

The coronavirus outbreak left organisations with no choice but to work remotely when stay-at-home measures were introduced, driving the need to invest in digital technology overnight. The CEO of Microsoft, Satya Nadella, announced that, due to the pandemic, Microsoft witnessed “two years’ worth of digital transformation in two months”. This can be supported by an annual survey conducted by McKinsey Global with comparisons between previous and recent data showing that, due to the pandemic, 899 companies across a range of regions, company sizes and industries are accelerating their interaction of supply chains and in-house operations via digital means by 3–4 years [104].

Before the COVID-19 pandemic, survey data collected from 99 industry product leaders from across Europe, the Middle East and Africa gained insight to the forecast of I4.0 technologies. The results showed that the technologies with most impact are IoT, AI and Cloud infrastructure [105]. These technologies operate well collectively to increase connectivity, allowing for improved monitoring of various processes, whilst also increasing system intelligence and flexibility [106].

The global annual survey performed by Deloitte received over 1800 replies from global industries of all shapes and sizes regarding what they forecast to be the key impacting technologies on their business. The data provided in Figure 18 show that IoT, AI and Cloud are considered to have the greatest impact, whereas technologies such as edge and quantum computing, 3D printing, AR and blockchain have the least impact.

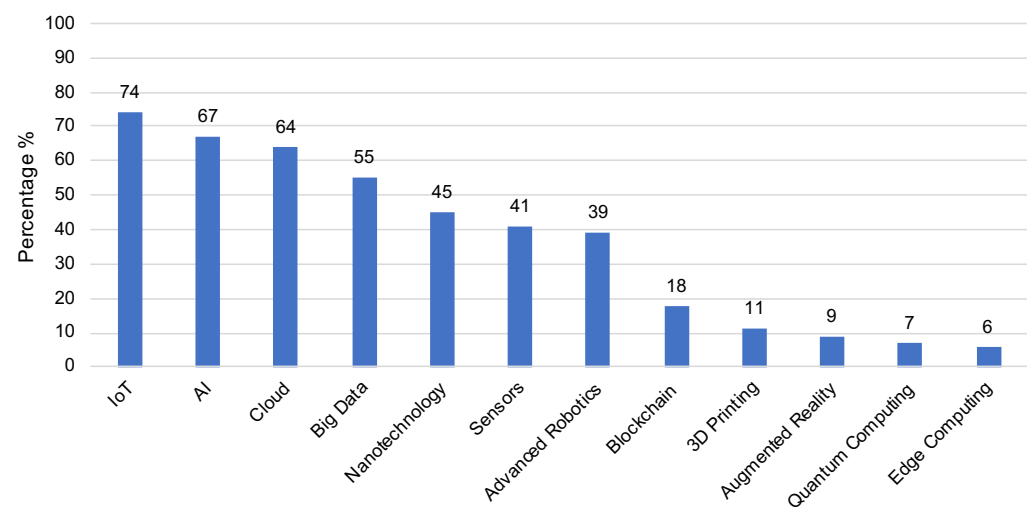

Figure 18. Global Industries Prediction on Technology Impact ($n = 1802$) [105].

The technologies presented (Figure 18) are forecast to have a high impact and also show a requirement for a high level of connectivity. Recent developments in sensory technology have the potential to enable large amounts of information to be collected from real-life systems. Strategic placing and access to these sensors enable the manufacturing system to make timely reactions to changing customer demands.

6.2. Festo Flexible Manufacturing System (FMS)

The use case detailed here with the scaled Festo Flexible Manufacturing System (FMS), which is an outcome from the research work conducted by the team at Edinburgh Napier University [107], features a scaled-down, flexible manufacturing environment. The FMS provides a platform for testing and analysing various manufacturing scenarios. The system, as detailed in Figure 19, consists of six stations with a central conveyor. Three of the six

stations handle the processing of components, from processing the components in and out of the system along with internal processing. The remaining three stations consist of quality checking via a vision system, robotic assembly and warehouse storage for subsequent distribution.

Currently, the system (illustrated in Figure 19) consists of multiple individual Siemens Programmable Logic Controllers (PLCs) with Supervisory Control and Data Acquisition (SCADA) for the monitoring and control of all processes. This configuration operates well for supervising and controlling the manufacturing plant. However, increasing agility in the manufacturing process in relation to the rising demand for customised products requires an increased level of connection to gather information on the status of the entire process, thereby enabling executive decisions based on (1) the demand for products, (2) product type and (3) current state of the manufacturing process.

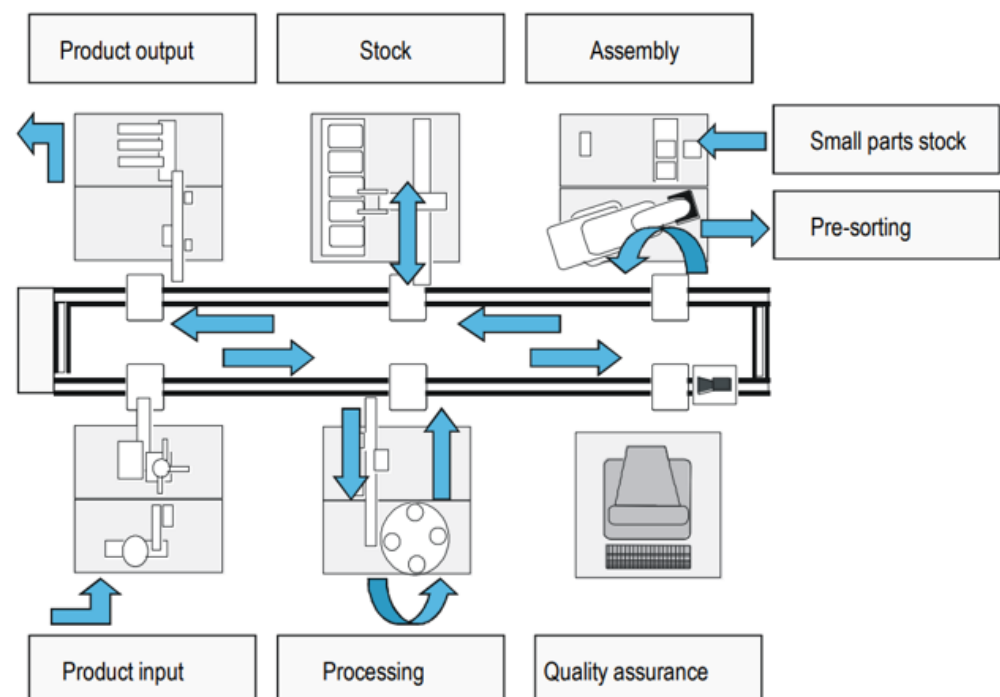

Figure 19. Flexible Manufacturing System (FMS) featuring six modular stations from component input to internal processing, quality checking, robotic assembly, storage and final product output [108].

This FMS and other industrial systems increasingly develop digital solutions in the future. Innovations, such as smart sensory technology, IoT and cyber-physical systems (CPS), have the potential to integrate physical and virtual worlds, providing increasingly flexible manufacturing solutions required to satisfy customers' demands. With regard to communication, the practical application of technologies requiring high connectivity, such as IoT and CPS, rely on mobile-internet links [109]. However, industrial control systems require communication that enables low levels of latency, particularly automation systems that require real-time motion control. Although many beneficial features of wireless communication can be observed, such as flexibility for the moving of machinery and less cabling, the higher reliability of hard-wired connections outweighs the benefits of wireless. However, some Industry 4.0 technologies, such as mobile autonomous systems and the connection of devices from various suppliers, have little to no option for hard-wired communication, and therefore, these technologies require highly reliable, low-latency wireless communication.

Figure 20 illustrates the scaled manufacturing environment at Edinburgh Napier University. This manufacturing environment is also challenged with the points mentioned

previously. Current control of the machines is provided via local controllers; however, with the availability of increasing reliable and efficient connection, opportunities for increased monitoring along with internet-based diagnostic and control is possible, hence, overcoming the current challenges of connecting the physical system and virtual space.



Figure 20. Scaled Flexible Manufacturing System at Edinburgh Napier University.

6.3. Challenges and Future Directions

Established manufacturing environments operate automation processes with legacy equipment via robust communication means. During the 3rd industrial revolution, when operations were automated via logic controllers and information technology, there was little to no requirement to send sensory information outside of the control of the local automation system. Industry 4.0 introduced technology that requires increased levels of connectivity [100]. This makes the practical implementation of Industry 4.0 difficult when attempting to integrate the enabling technologies whilst guaranteeing robust performance [110]. Barriers, such as legacy system integration with Industry 4.0 technologies, are challenging organisations to adopt new technology. Therefore, communication technology that assists with the integration of robust legacy platforms and IoT platforms whilst guaranteeing reliability and latency is fundamental for the development of Industry 4.0.

Recent developments in sensory technology have the potential to enable large amounts of information to be collected from real-life systems. Strategic placing and access to these sensors enable the manufacturing system to make timely reactions to changes in customer demands. From this case study, it can be identified that for the sensing, analysis and control of a manufacturing system, such as the FMS described here, it is vital that there is a high level of connectivity. This presents some challenges for established manufacturing environments with investments in technology that are not designed with this level of connectivity in mind. A requirement for this case is also that the information distributed around the system is achieved in a timely manner.

For successful implementation of machine learning technologies (also forecast to have high impacts to industry) time-sensitive datasets are required. Hence, this example would highly benefit from two of the three key drivers proposed for 6G: (1) connection of all things and (2) time-sensitive applications.

7. Challenges and Opportunities in the Context of 6G

This section aims to bring together the main aspects that were highlighted earlier in the paper regarding the main challenges faced by the use cases and the role that 6G can play to fill the current gaps. Table 1 summarises the main challenges, opportunities offered

by 6G, and the relevant literature cited across the paper. It can be seen from the information presented in the table that the high data rates, ultra-low latency, and connectivity of all things, envisaged to be offered by 6G, will play a vital role in overcoming some of the challenges faced by the use cases.

6G will undoubtedly bring solutions to many of the issues that the world is facing nowadays, and open up new opportunities. Nevertheless, several challenges are predicted to face the implementation of 6G and its enabling technology. The literature has reported several challenges, including the difficulty in generating the output power with the increased frequency, due to, for example, the Johnson limit [111]. Moreover, the challenge of powering the massive networks that are envisaged to connect the millions of devices required, and providing coverage across all potential locations at any point in time was reported [112].

Table 1. A collective summary of the challenges, opportunities, and future directions of the presented use cases, in the context of 6G.

Sector	Use Case	Challenges	Opportunities and Future Directions: What Can 6G Offer?	Relevant Literature
Healthcare	Human Activity Monitoring [34]	<ol style="list-style-type: none"> 1. High latency 2. Limited number of sensing nodes 3. Reliable communication of critical information 	<ol style="list-style-type: none"> 1. High data rates 2. Ultra-low latency 3. Unlimited number of sensing nodes by integrating them in the 6G radio antennas 4. Utilising IRS 	[19,24–27,32–42]
	Assistive Technologies for the Visually Impaired [49]	<ol style="list-style-type: none"> 1. Limited Number of objects' classification 2. Limited computing power 3. Delay in video feed 	<ol style="list-style-type: none"> 1. Edge Computing 2. Ultra-lo latency 3. Large network coverage 	[43–45,45–58]
Smart Grid	Promoting Energy-conscious Behaviour in the NHS [66]	<ol style="list-style-type: none"> 1. Limited data logging rates 2. Limited data resolution 3. Limited energy-load resolution 	<ol style="list-style-type: none"> 1. Network Intelligence 2. Service Intelligence 3. High data rates 4. Ultra-low latency 5. Unlimited number of energy sensing nodes 	[2,18], [59–81]
Transport	Predicting the Intent to Return to a Vehicle [90–92]	Real-time ubiquitous communication between the driver and the car	<ol style="list-style-type: none"> 1. Connectivity for all things 2. Ultra-low latency 3. High data rates 4. Reliable communication links 	[82–93]
Industry 4.0	Festo Flexible Manufacturing System [107]	<ol style="list-style-type: none"> 1. Reliable connectivity 2. Timely communication of information 	<ol style="list-style-type: none"> 1. Connectivity for all things 2. Ultra-low latency 3. High data rates 4. Reliable communication links 	[96–106,108,109]

8. Conclusions

6G technology is promising to revolutionise many industries and is believed to be the foundation for the realisation of the full potential of the IoT. However, the literature has had its say on the future of 6G and whether or not it is capable of fulfilling the growing connectivity demand, across all societies and industries. Not surprisingly, numerous studies in the literature have started conceptualising and identifying potential use cases that will benefit from the 6th generation of mobile networks.

In this paper, we presented a novel approach to the review of the literature around the potential of 6G technology, especially in the context of the IoT. The authors discussed five use cases from previous studies conducted in the health, energy, transport, and industry

sectors. The motivation behind the chosen approach was to go beyond conceptualisation and identify where 6G and its enabling technologies can be of use across various societal domains.

As highlighted in the use cases, the future wireless networks have several challenges to provide the different sectors with a reliable communication link. These challenges open the way for scholars to push the limitations of what is currently possible. In the following, we highlight the main open research questions, with respect to the key drivers of 6G, to incorporate the technology in each of the use cases.

The first driver is the high fidelity holographic society, which refers to the applications that have simultaneous and interactive communication. The question that arises from the use case is as follows:

- Assistive technologies for the visually impaired:
 - Can 6G provide users with real-time video-streaming capabilities? If 6G is able to significantly reduce the end-to-end latency and improve the information freshness, then can we improve the usability of the assistive technologies with the connection to the cloud?

The second driver is the massive number of connected devices, referred to as “Connectivity for All Things”. Most of the presented use cases require a reliable connectivity, and the questions arisen are the following:

- Human activity monitoring:
 - To what extent could the concept of 6G sensing contribute to the state of the art of the in-home monitoring of activities?
- Assistive technologies for the visually impaired:
 - How can we provide ubiquitous coverage to rural areas using 6G, where visually-impaired users may be located?
- Smart grid:
 - Can 6G and its enabling technologies help increase the data resolution of energy monitoring to improve energy-conscious behaviour and make contributions towards the 2050 Net Zero carbon target?
- Industry 4.0 :
 - Can 6G communication overcome the challenge of integrating highly robust legacy automation equipment with Industry 4.0 enabling technologies?

The last driver is time-sensitive applications. The open research question are as follows:

- Human activity monitoring:
 - Can 6G and its enabling technologies help facilitate the switching from hospital care to in-home care through the real-time monitoring of patients?
- Transport:
 - What is the best location to do the computationally complex calculations in future transport systems? In answering this question, it can help manufacturers to determine the best network topology and requirements.
 - Can 6G communication provide robust reliability and the required latency for the real-time control of industrial automation systems powered by machine-learning algorithms?

The authors are convinced that the envisaged potential for 6G and its enabling technologies will have nothing but positive impacts on the presented use cases and the societal sectors that they represent, and will be key in addressing major worldwide issues, such as the ageing population and climate change.

Author Contributions: Conceptualisation, B.B. and A.T.; IoT Use Cases B.B., A.T., R.S., A.S., S.A. and P.M.L.; writing—original draft preparation, B.B., A.T., R.S., A.S. and S.A.; writing—review and editing, B.B., A.T. and I.J.W.; supervision, S.K., Q.H.A. and M.A.I. All authors have read and agreed to the published version of the manuscript.

Funding: This research received no external funding.

Data Availability Statement: Data sharing is not applicable to this article.

Conflicts of Interest: The authors declare no conflict of interest.

References

1. ITU FG-Net-2030. Network 2030 (A Blueprint of Technology, Applications and Market Drivers Towards the Year 2030 and Beyond Written). *ITU Web Site* **2020**, *1*, 19.
2. Tataria, H.; Shafi, M.; Molisch, A.F.; Dohler, M.; Sjöland, H.; Tufvesson, F. 6G Wireless Systems: Vision, Requirements, Challenges, Insights, and Opportunities. Available online: <https://arxiv.org/pdf/2008.03213.pdf> (accessed on 12 June 2021)
3. Simsek, M.; Aijaz, A.; Dohler, M.; Sachs, J.; Fettweis, G. 5G-enabled tactile internet. *IEEE J. Sel. Areas Commun.* **2016**, *34*, 460–473. [[CrossRef](#)]
4. Aijaz, A.; Sooriyabandara, M. The tactile internet for industries: A review. *Proc. IEEE* **2018**, *107*, 414–435. [[CrossRef](#)]
5. Atzori, L.; Iera, A.; Morabito, G. The internet of things: A survey. *Comput. Netw.* **2010**, *54*, 2787–2805. [[CrossRef](#)]
6. Barakat, B.; Keates, S.; Wassell, I.J.; Arshad, K. Modelling IoT devices communication employing representative operation modes to reveal traffic generation characteristics. *Int. J. Parallel Emergent Distrib. Syst.* **2021**, *36*, 117–129. [[CrossRef](#)]
7. Sundaravadivel, P.; Kougianos, E.; Mohanty, S.P.; Ganapathiraju, M.K. Everything You Wanted to Know about Smart Health Care: Evaluating the Different Technologies and Components of the Internet of Things for Better Health. *IEEE Consum. Electron. Mag.* **2018**, *7*, 18–28. [[CrossRef](#)]
8. Spanò, E.; Niccolini, L.; Di Pascoli, S.; Iannacconeluca, G. Last-meter smart grid embedded in an Internet-of-Things platform. *IEEE Trans. Smart Grid* **2014**, *6*, 468–476. [[CrossRef](#)]
9. Perallos, A.; Hernandez-Jayo, U.; Onieva, E.; Garcí, I.J. *Intelligent Transport Systems: Technologies and Applications*; John Wiley & Sons: Hoboken, NJ, USA, 2015.
10. Statista Research Department. *Number of IoT Devices 2015–2025*; Statista: Hamburg, Germany, 2016.
11. Barakat, B.; Arshad, K. Energy efficient scheduling in LTE-advanced for Machine Type Communication. In Proceedings of the 2015 International Conference and Workshop on Computing and Communication (IEMCON), Vancouver, BC, Canada, 15–17 October 2015; pp. 1–5.
12. Akyildiz, I.F.; Kak, A.; Nie, S. 6G and Beyond: The Future of Wireless Communications Systems. *IEEE Access* **2020**, *8*, 133995–134030. [[CrossRef](#)]
13. Giordani, M.; Polese, M.; Mezzavilla, M.; Rangan, S.; Zorzi, M. Toward 6G Networks: Use Cases and Technologies. *IEEE Commun. Mag.* **2020**, *58*, 55–61. [[CrossRef](#)]
14. You, X.; Wang, C.X.; Huang, J.; Gao, X.; Zhang, Z.; Wang, M.; Huang, Y.; Zhang, C.; Jiang, Y.; Wang, J.; et al. Towards 6G wireless communication networks: Vision, enabling technologies, and new paradigm shifts. *Sci. China Inf. Sci.* **2021**, *64*, 1–74. [[CrossRef](#)]
15. Chowdhury, M.Z.; Member, S.; Member, S.; Ahmed, S.; Jang, Y.M. 6G Wireless Communication Systems : Applications , Research Directions. *IEEE Open J. Commun. Soc.* **2020**, *1*, 957–975. [[CrossRef](#)]
16. Alsharif, M.H.; Kelechi, A.H.; Albreem, M.A.; Chaudhry, S.A.; Zia, M.S.; Kim, S. Sixth Generation (6G) Wireless Networks: Vision, Research Activities, Challenges and Potential Solutions. *Symmetry* **2020**, *12*, 676. [[CrossRef](#)]
17. Chowdhury, M.Z.; Ahmed, S.; Jang, Y.M.I.N. 6G Wireless Communication Systems: Applications. *IEEE Netw.* **2020**, *1*, 957–975.
18. Elmeadawy, S.; Shubair, R.M. 6G Wireless Communications: Future Technologies and Research Challenges. In Proceedings of the 2019 International Conference on Electrical and Computing Technologies and Applications (ICECTA), Ras Al Khaimah, United Arab Emirates, 19–21 November 2019; pp. 1–5. [[CrossRef](#)]
19. Shah, S.A.; Fioranelli, F. RF Sensing Technologies for Assisted Daily Living in Healthcare: A Comprehensive Review. *IEEE Aerosp. Electron. Syst. Mag.* **2019**, *34*, 26–44. [[CrossRef](#)]
20. Lloret, J.; Canovas, A.; Sendra, S.; Parra, L. A smart communication architecture for ambient assisted living. *IEEE Commun. Mag.* **2015**, *53*, 26–33. [[CrossRef](#)]
21. Baker, S.B.; Xiang, W.; Atkinson, I. Internet of Things for Smart Healthcare: Technologies, Challenges, and Opportunities. *IEEE Access* **2017**, *5*, 26521–26544. [[CrossRef](#)]
22. Zhao, W.; Luo, X.; Qiu, T. Smart healthcare. *Appl. Sci.* **2017**, *7*, 3–7. [[CrossRef](#)]
23. Mucchi, L.; Jayousi, S.; Caputo, S.; Paoletti, E.; Zoppi, P.; Geli, S.; Dioniso, P. How 6G Technology Can Change the Future Wireless Healthcare. In Proceedings of the 2020 2nd 6G Wireless Summit (6G SUMMIT), Levi, Finland, 17–20 March 2020; pp. 1–6. [[CrossRef](#)]
24. Ding, S.; Chen, Z.; Zheng, T.; Luo, J. RF-net: A unified meta-learning framework for RF-enabled one-shot human activity recognition. In Proceedings of the SenSys 2020—Proceedings of the 2020 18th ACM Conference on Embedded Networked Sensor Systems, New York, NY, USA, 16–19 November 2020; pp. 517–530. [[CrossRef](#)]

25. Taylor, W.; Shah, S.A.; Dashtipour, K.; Zahid, A.; Abbasi, Q.H.; Imran, M.A. An intelligent non-invasive real-time human activity recognition system for next-generation healthcare. *Sensors* **2020**, *20*, 2653. [CrossRef]
26. Uysal, C.; Filik, T. RF-Based noncontact respiratory rate monitoring with parametric spectral estimation. *IEEE Sens. J.* **2019**, *19*, 9841–9849. [CrossRef]
27. Wang, X.; Yang, C.; Mao, S. On CSI-Based Vital Sign Monitoring Using Commodity WiFi. *ACM Trans. Comput. Healthc.* **2020**, *1*, 1–27. [CrossRef]
28. Schmitz, J.; Bartsch, F.; Hernandez, M.; Mathar, R. Distributed software defined radio testbed for real-time emitter localization and tracking. In Proceedings of the 2017 IEEE International Conference on Communications Workshops (ICC Workshops), Paris, France, 21–25 May 2017; pp. 1246–1252. [CrossRef]
29. Cao, X.; Chen, Y.; Liu, K.J.R. *High Accuracy Indoor Localization: A Wifi-Based Approach*; IEEE: New York City, NY, USA, 2016; Volume 1, pp. 6220–6224.
30. Shi, S.; Sigg, S.; Chen, L.; Ji, Y. Accurate Location Tracking from CSI-Based Passive Device-Free Probabilistic Fingerprinting. *IEEE Trans. Veh. Technol.* **2018**, *67*, 5217–5230. [CrossRef]
31. Yang, M.; Chuo, L.X.; Suri, K.; Liu, L.; Zheng, H.; Kim, H.S. *ILPS: Local Positioning System with Simultaneous Localization and Wireless Communication*; IEEE: New York City, NY, USA, 2019; Volume 2019, pp. 379–387. [CrossRef]
32. Coluccia, A.; Parisi, G.; Fascista, A. Detection and Classification of Multirotor Drones in Radar Sensor Networks: A Review. *Sensors* **2020**, *20*, 4172. [CrossRef]
33. Luo, F.; Poslad, S.; Bodanese, E. Human Activity Detection and Coarse Localization Outdoors Using Micro-Doppler Signatures. *IEEE Sens. J.* **2019**, *19*, 8079–8094. [CrossRef]
34. Ashleibta, A.M.; Zahid, A.; Shah, S.A.; Abbasi, Q.H.; Imran, M.A. Flexible and scalable software defined radio based testbed for large scale body movement. *Electronics* **2020**, *9*, 1354. [CrossRef]
35. QUEST(2020). Future of Smart Health-Care. Available online: <https://healthcare-quest.com/research> (accessed on 14 May 2021).
36. University of Glasgow. University News—£5.5 m Funding Boost for Home Healthcare Monitoring Technology. Available online: https://www.gla.ac.uk/news/headline_739038_en.html (accessed on 12 June 2021).
37. Wang, Y.; Liu, J.; Chen, Y.; Gruteser, M.; Yang, J.; Liu, H. E-eyes: Device-free location-oriented activity identification using fine-grained wifi signatures. In Proceedings of the 20th Annual International Conference on Mobile Computing and Networking, Maui, HI, USA, 7–11 September 2014; pp. 617–628.
38. Ma, Y.; Zhou, G.; Wang, S. WiFi sensing with channel state information: A survey. *ACM Comput. Surv. (CSUR)* **2019**, *52*, 1–36. [CrossRef]
39. Narayanan, R.M.; Shastry, M.C.; Chen, P.H.; Levi, M. Through-the-wall detection of stationary human targets using Doppler radar. *Prog. Electromagn. Res.* **2010**, *20*, 147–166. [CrossRef]
40. Liu, J.; Wang, L.; Guo, L.; Fang, J.; Lu, B.; Zhou, W. A research on CSI-based human motion detection in complex scenarios. In Proceedings of the 2017 IEEE 19th International Conference on e-Health Networking, Applications and Services (Healthcom), Dalian, China, 12–15 October 2017; pp. 1–6.
41. Long, W.; Chen, R.; Moretti, M.; Zhang, W.; Li, J. A Promising Technology for 6G Wireless Networks: Intelligent Reflecting Surface. *J. Commun. Inf. Netw.* **2021**, *6*, 1–16.
42. Cui, T.J.; Zoha, A.; Li, L.; Shah, S.A.; Alomainy, A.; Imran, M.A.; Abbasi, Q.H. Revolutionizing Future Healthcare using Wireless on the Walls (WoW). *arXiv* **2020**, arXiv:2006.06479.
43. Office for National Statistics (ONS). *What Is My Life Expectancy? And How Might It Change?*; Office for National Statistics: Newport, UK, 2017.
44. World Health Organization. Blindness and Vision Impairment. Available online: <https://www.who.int/news-room/fact-sheets/detail/blindness-and-visual-impairment> (accessed on 12 June 2021).
45. Pezzullo, L.; Streatfeild, J.; Simkiss, P.; Shickle, D. The economic impact of sight loss and blindness in the UK adult population. *BMC Health Serv. Res.* **2018**, *18*, 1–13. [CrossRef]
46. United Nations. World Population Ageing. Available online: https://www.un.org/development/desa/pd/sites/www.un.org/development/desa/pd/files/undesa_pd-2020_world_population_ageing_highlights.pdf (accessed on 12 June 2021).
47. Lafuma, A.; Brézin, A.; Lopatriello, S.; Hieke, K.; Hutchinson, J.; Mimaud, V.; Berdeaux, G. Evaluation of non-medical costs associated with visual impairment in four European countries. *Pharmacoeconomics* **2006**, *24*, 193–205. [CrossRef]
48. Guo, Y.; Liu, Y.; Oerlemans, A.; Lao, S.; Wu, S.; Lew, M.S. Deep learning for visual understanding: A review. *Neurocomputing* **2016**, *187*, 27–48. [CrossRef]
49. Barakat, B.; Steponenaite, A.; Lall, G.S.; Arshad, K.; Wassell, I.J.; Keates, S. Assistive technology for the visually impaired: Optimizing frame rate (freshness) to improve the performance of real-time objects detection application. In *International Conference on Human-Computer Interaction*; Springer: Berlin/Heidelberg, Germany, 2020; pp. 479–492.
50. Lin, T.Y.; Maire, M.; Belongie, S.; Hays, J.; Perona, P.; Ramanan, D.; Dollár, P.; Zitnick, C.L. Microsoft coco: Common objects in context. In *European Conference on Computer Vision*; Springer: Berlin/Heidelberg, Germany, 2014; pp. 740–755.
51. Redmon, J.; Farhadi, A. Yolov3: An incremental improvement. *arXiv* **2018**, arXiv:1804.02767.
52. Huang, L.; Modiano, E. Optimizing age-of-information in a multi-class queueing system. In Proceedings of the 2015 IEEE International Symposium on Information Theory (ISIT), Hong Kong, China, 14–19 June 2015; pp. 1681–1685.

53. Costa, M.; Codreanu, M.; Ephremides, A. On the age of information in status update systems with packet management. *IEEE Trans. Inf. Theory* **2016**, *62*, 1897–1910. [CrossRef]
54. Barakat, B.; Yassine, H.; Keates, S.; Wassell, I.; Arshad, K. How to measure the average and peak age of information in real networks? European Wireless 2019. In Proceedings of the 25th European Wireless Conference, VDE, Aarhus, Denmark, 2–4 May 2019; pp. 1–5.
55. Barakat, B.; Keates, S.; Wassell, I.; Arshad, K. Is the zero-wait policy always optimum for information freshness (peak age) or throughput? *IEEE Commun. Lett.* **2019**, *23*, 987–990. [CrossRef]
56. GitHub. cokelaer/fitter: Fit data to many distributions. Available online: <https://github.com/cokelaer/fitter> (accessed on 12 June 2021).
57. Bertsekas, D.P.; Gallager, R.G.; Humblet, P. *Data Networks*; Prentice-Hall International: New Jersey, NJ, USA, 1992; Volume 2.
58. Barakat, B.; Keates, S.; Wassell, I.; Arshad, K. Adaptive status arrivals policy (ASAP) delivering fresh information (Minimise Peak Age) in real world scenarios. In *International Conference on Human-Computer Interaction*; Springer: Cham, Switzerland 2019; pp. 419–430.
59. DBEIS. *UK Becomes First Major Economy to Pass Net Zero Emissions Law—GOV.UK*; DBEIS: London, UK, 2019.
60. Geelen, D.; Mugge, R.; Silvester, S.; Bulters, A. The use of apps to promote energy saving: A study of smart meter-related feedback in the Netherlands. *Energy Effic.* **2019**, *12*, 1635–1660. [CrossRef]
61. Emeakaroha, A.; Ang, C.S.; Yan, Y.; Hophthrow, T. A persuasive feedback support system for energy conservation and carbon emission reduction in campus residential buildings. *Energy Build.* **2014**, *82*, 719–732. [CrossRef]
62. Petersen, J.E.; Shunturov, V.; Janda, K.; Platt, G.; Weinberger, K. Dormitory residents reduce electricity consumption when exposed to real-time visual feedback and incentives. *Int. J. Sustain. High. Educ.* **2007**, *8*, 16–33. [CrossRef]
63. Kavousian, A.; Rajagopal, R.; Fischer, M. Determinants of residential electricity consumption: Using smart meter data to examine the effect of climate, building characteristics, appliance stock, and occupants' behavior. *Energy* **2013**, *55*, 184–194. [CrossRef]
64. Froehlich, J. Promoting Energy Efficient Behaviors in the Home through Feedback : The Role of Human-Computer Interaction. *Proc. HCIC Workshop* **2009**, *4*, 11.
65. Spataru, C.; Gauthier, S. How to monitor people 'smartly' to help reducing energy consumption in buildings? *Archit. Eng. Des. Manag.* **2014**, *10*, 60–78. [CrossRef]
66. Taha, A.; Wu, R.; Emeakaroha, A.; Krabicka, J. Reduction of Electricity Costs in Medway NHS by Inducing Pro-Environmental Behaviour Using Persuasive Technology. *Future Cities Environ.* **2018**, *4*, 1–10. [CrossRef]
67. Koroleva, K.; Melenhorst, M.; Novak, J.; Herrera Gonzalez, S.L.; Fraternali, P.; Rizzoli, A.E. Designing an integrated socio-technical behaviour change system for energy saving. *Energy Inform.* **2019**, *2*, 30. [CrossRef]
68. McHenry, M.P. Technical and governance considerations for advanced metering infrastructure/smart meters: Technology, security, uncertainty, costs, benefits, and risks. *Energy Policy* **2013**, *59*, 834–842. [CrossRef]
69. Vinagre, E.; De Paz, J.F.; Pinto, T.; Vale, Z.; Corchado, J.M.; Garcia, O. Intelligent energy forecasting based on the correlation between solar radiation and consumption patterns. *IEEE Symp. Ser. Comput. Intell.* **2017**. [CrossRef]
70. Sharma, E. Energy forecasting based on predictive data mining techniques in smart energy grids. *Energy Inform.* **2018**, *1*. [CrossRef]
71. Bolton, P.; Barber, S.; Hinson, S. *Energy Smart Meters*; Technical Report; UK Parliament: London, UK, 2019.
72. Wei, C.; Li, Y. Design of energy consumption monitoring and energy-saving management system of intelligent building based on the Internet of things. In Proceedings of the International Conference on Electronics, Communications and Control, ICECC 2011—Proceedings, Ningbo, China, 9–11 September 2011; pp. 3650–3652. [CrossRef]
73. Hartman, W.T.; Hansen, A.; Vasquez, E.; El-Tawab, S.; Altaii, K. Energy monitoring and control using Internet of Things (IoT) system. In Proceedings of the Systems and Information Engineering Design Symposium, SIEDS, Charlottesville, VA, USA, 27 April 2018; pp. 13–18. [CrossRef]
74. Muralidhara, S.; Hegde, N.; PM, R. An internet of things-based smart energy meter for monitoring device-level consumption of energy. *Comput. Electr. Eng.* **2020**, *87*, 106772. [CrossRef]
75. Motlagh, N.H.; Mohammadrezaei, M.; Hunt, J.; Zakeri, B. Internet of things (IoT) and the energy sector. *Energies* **2020**, *13*, 494. [CrossRef]
76. Shivaraman, N.; Saki, S.; Liu, Z.; Ramanathan, S.; Easwaran, A.; Steinhorn, S. Real-Time Energy Monitoring in IoT-enabled Mobile Devices. In Proceedings of the 2020 Design, Automation and Test in Europe Conference and Exhibition, DATE 2020, Grenoble, France, 9–13 March 2020; pp. 991–994. [CrossRef]
77. Joseph, A.; Paynter, W.; Thomson, J. High-Resolution Residential Electricity Use Data for Improved Realism in Building Energy Simulations. Available online: <http://www.ibpsa.org/proceedings/eSimPapers/2016/19-100-eSim2016.pdf> (accessed on 12 June 2021).
78. Fogg, B.J. A Behavior Model for Persuasive Design. In Proceedings of the 4th International Conference on Persuasive Technology, Claremont, CA, USA, 26–29 April 2009; ACM: New York, NY, USA, 2009; Persuasive '09, pp. 40:1–40:7. [CrossRef]
79. Hui, H.; Ding, Y.; Shi, Q.; Li, F.; Song, Y.; Yan, J. 5G network-based Internet of Things for demand response in smart grid: A survey on application potential. *Appl. Energy* **2020**, *257*, 113972. [CrossRef]
80. Nayak, S.; Patgiri, R. 6G Communication: Envisioning the Key Issues and Challenges. *EAI Endorsed Trans. Internet Things* **2021**, *6*, 166959. [CrossRef]

81. Alsharif, M.H.; Kelechi, A.H.; Albreem, M.A.; Chaudhry, S.A.; Zia, M.S.; Kim, S. SS symmetry and Potential Solutions. *Symmetry* **2020**, *12*, 11.
82. Toh, C.K.; Sanguesa, J.A.; Cano, J.C.; Martinez, F.J. Advances in smart roads for future smart cities. *Proc. R. Soc. Math. Phys. Eng. Sci.* **2020**, *476*. [[CrossRef](#)]
83. Elkosantini, S.; Darmoul, S. Intelligent public transportation systems: A review of architectures and enabling technologies. *Int. Conf. Adv. Logist. Transp.* **2013**, 233–238. [[CrossRef](#)]
84. Taxonomy, S. *Definitions for Terms Related to On-Road Motor Vehicle Automated Driving Systems*; Society of Automotive Engineers (SAE): Troy, MI, USA, 2014.
85. Arena, F.; Pau, G.; Severino, A. An Overview on the Current Status and Future Perspectives of Smart Cars. *Infrastructures* **2020**, *5*, 1–16. [[CrossRef](#)]
86. Coppola, R.; Morisio, M. Connected car: Technologies, issues, future trends. *ACM Comput. Surv.* **2016**, *49*, 1–36. [[CrossRef](#)]
87. Zheng, K.; Zheng, Q.; Chatzimisios, P.; Xiang, W.; Zhou, Y. Heterogeneous vehicular networking: A survey on architecture, challenges, and solutions. *IEEE Commun. Surv. Tutorials* **2015**, *17*, 2377–2396. [[CrossRef](#)]
88. Schwarz, S.; Philosof, T.; Rupp, M. Signal processing challenges in cellular-assisted vehicular communications: Efforts and developments within 3GPP LTE and beyond. *IEEE Signal Process. Mag.* **2017**, *34*, 47–59. [[CrossRef](#)]
89. Seredynski, M.; Viti, F. A survey of cooperative ITS for next generation public transport systems. In Proceedings of the 2016 IEEE 19th International Conference on Intelligent Transportation Systems (ITSC), Rio de Janeiro, Brazil, 1–4 November 2016; pp. 1229–1234.
90. Ahmad, B.I.; Langdon, P.M.; Godsill, S.J.; Delgado, M.; Popham, T. If and when a driver or passenger is returning to vehicle: Framework to infer intent and arrival time. *arXiv* **2017**, arXiv:1709.07381.
91. Ahmad, B.I.; Langdon, P.M.; Godsill, S.J. A Meta-Tracking Approach for Predicting the Driver or Passenger Intent. In Proceedings of the 2018 21st International Conference on Information Fusion, FUSION, Cambridge, UK, 10–13 July 2018; pp. 617–621. [[CrossRef](#)]
92. Ahmad, B.I.; Langdon, P.M.; Godsill, S.J. A Bayesian Framework for Intent Prediction in Object Tracking. In Proceedings of the ICASSP, IEEE International Conference on Acoustics, Speech and Signal Processing—Proceedings, Brighton, UK, 12–17 May 2019; pp. 8439–8443. [[CrossRef](#)]
93. Bishop, C.M. *Pattern Recognition and Machine Learning*; Springer: Berlin/Heidelberg, Germany, 2006.
94. De Lima, C.; Belot, D.; Berkvens, R.; Bourdoux, A.; Dardari, D.; Guillaud, M.; Isomursu, M.; Lohan, E.S.; Miao, Y.; Barreto, A.N.; et al. Convergent communication, sensing and localization in 6G systems: An overview of technologies, opportunities and challenges. *IEEE Access* **2021**, *1*, 1.
95. Fascista, A.; Coluccia, A.; Wymeersch, H.; Seco-Granados, G. Downlink Single-Snapshot Localization and Mapping with a Single-Antenna Receiver. *IEEE Trans. Wirel. Commun.* **2021**, *1*, 1. [[CrossRef](#)]
96. Wan, J.; Yi, M.; Li, D.; Zhang, C.; Wang, S.; Zhou, K. Mobile services for customization manufacturing systems: An example of industry 4.0. *IEEE Access* **2016**, *4*, 8977–8986. [[CrossRef](#)]
97. Wang, Y.; Ma, H.S.; Yang, J.H.; Wang, K.S. Industry 4.0: a way from mass customization to mass personalization production. *Adv. Manuf.* **2017**, *5*, 311–320. [[CrossRef](#)]
98. Frank, A.G.; Dalenogare, L.S.; Ayala, N.F. Industry 4.0 technologies: Implementation patterns in manufacturing companies. *Int. J. Prod. Econ.* **2019**, *210*, 15–26. [[CrossRef](#)]
99. Engines, S. Industry 4.0 and how smart sensors make the difference. *Luettu* **2018**, *9*, 2020. Available online: <https://www.spectralengines.com/articles/industry-4-0-and-how-smart-sensors-make-the-difference> (accessed on 12 June 2021).
100. Gilchrist, A. *Industry 4.0: The Industrial Internet of Things*; Springer: Berlin/Heidelberg, Germany, 2016.
101. Benitez, G.B.; Lima, M.J.d.R.F.; Lerman, L.V.; Frank, A.G. Understanding Industry 4.0: Definitions and insights from a cognitive map analysis. *Braz. J. Oper. Prod. Manag.* **2019**, *16*, 192–200. [[CrossRef](#)]
102. Caylar, P.L.; Noterdaeme, O.; Naik, K. Digital in industry: From buzzword to value creation. *Mckinsey Company. Digit. Mckinsey* **2016**, *2*, 1.
103. Li, D.; Fast-Berglund, Å.; Paulin, D. Current and future Industry 4.0 capabilities for information and knowledge sharing. *Int. J. Adv. Manuf. Technol.* **2019**, *105*, 3951–3963. [[CrossRef](#)]
104. Laura, L.; Clayton, O.; Jeremy, S.; Kate, S. *How COVID-19 Has Pushed Companies over the Technology Tipping Point and Transformed Business Forever*; McKinsey Company: Hong Kong, China, 2020; Volume 5.
105. Firm, D.D.L. The Fourth Industrial Revolution: At the Intersection of Readiness and Responsibility. Available online: <https://www.forbes.com/sites/deloitte/2020/01/20/the-fourth-industrial-revolution-at-the-intersection-of-readiness-and-responsibility/?sh=317e458be9b0> (accessed on 12 June 2021).
106. Wan, J.; Yang, J.; Wang, Z.; Hua, Q. Artificial intelligence for cloud-assisted smart factory. *IEEE Access* **2018**, *6*, 55419–55430. [[CrossRef](#)]
107. McWhinnie, J.; Goh, K.; Yu, H.; Samson, R. *Robotics and Flexible Manufacture Laboratory*; Edinburgh Napier University, School of Engineering and the Built Environment (SEBE): Edinburgh, UK, 2020.
108. LabVolt Series by Festo Didactic—Contactor (3127-20). Available online: https://labvolt.festo.com/solutions/6_electricity_and_new_energy/50-3127-20_contactor (accessed on 12 June 2021).

109. Wollschlaeger, M.; Sauter, T.; Jasperneite, J. The future of industrial communication: Automation networks in the era of the internet of things and industry 4.0. *IEEE Ind. Electron. Mag.* **2017**, *11*, 17–27. [[CrossRef](#)]
110. Zawra, L.M.; Mansour, H.A.; Messiha, N.W. Migration of Legacy Industrial Automation Systems in the Context of Industry 4.0-A Comparative Study. In Proceedings of the 2019 International Conference on Fourth Industrial Revolution (ICFIR), Manama, Bahrain, 19–21 February 2019; pp. 1–7.
111. Johnson, E. Physical limitations on frequency and power parameters of transistors. In Proceedings of the 1958 IRE International Convention Record, New York City, NY, USA, 21–25 March 1966 ; Volume 13, pp. 27–34. [[CrossRef](#)]
112. Gustavsson, U.; Frenger, P.; Fager, C.; Eriksson, T.; Zirath, H.; Dielacher, F.; Studer, C.; Pärssinen, A.; Correia, R.; Matos, J.N.; et al. Implementation Challenges and Opportunities in Beyond-5G and 6G Communication. *IEEE J. Microwaves* **2021**, *1*, 86–100. [[CrossRef](#)]

Short Biography of Authors



Basel Barakat Basel Barakat a lecturer at the School of Engineering and Built Environment Edinburgh Napier University. He received his BSc, MSc and PhD from the University of Greenwich in 2013, 2014 and 2019. During his PhD, he was a visiting researcher at the University of Cambridge. Prior to his PhD, he worked as a Research Fellow at the University of Greenwich project titled ‘Towards 5G: Air interface Techniques to enhance carrier aggregation in the 5th generation of wireless communication (5G)’ investigating radio resources allocation for Internet of Things. His research interests are wireless communication, real-time systems, information freshness, Internet of things, machine learning, and mathematical modelling.



Ahmad Taha received his B.Sc. with Honours from October University for Modern Sciences and Arts (MSA) in Egypt in 2012. He was a recipient of two scholarship to pursue his M.Sc., after ranking 1st during his B.Sc., and PhD, after a successful Vice-Chancellor award application, in 2013 and 2016, respectively, at the University of Greenwich. Ahmad completed his M.Sc degree, with a distinction, in Embedded Systems in 2014 and his PhD in 2020, which was partially funded and in collaboration with Medway NHS Foundation Trust in Kent, UK. He is currently a Research Associate at the University of Glasgow (UofG) working in collaboration with several industrial and academic partners including Cisco and University of Strathclyde, on the 5G New Thinking project, funded by the Department for Digital, Culture, Media and Sport (DCMS). His research interests include the utilisation of the IoT in energy management applications, non-invasive wireless activity monitoring, and the applications of persuasive technology in various sectors of the society. He was nominated for the Energy Institute award in 2019 due to his contributions in technology-based energy-saving systems in the NHS.



Ryan Samson received both B.Eng. and M.Sc. from Edinburgh Napier University. Following the completion of his MSc in Automation and Control he was offered an associate lecturing position to help with teaching along with robotics lab development within the School of Engineering and Built Environment at Napier University, at this point his interest in teaching and research increased and motivated him to apply for a PhD position at Napier where the focus is to assist with the implementation of Industry 4.0 technology to the manufacturing sector.



Shuja Ansari (M’15-SM’20) received the M.Sc. degree (distinction) in Telecommunications Engineering in 2015, and the Ph.D. degree in Engineering in 2019 from Glasgow Caledonian University (GCU), UK. He is currently a Research Associate at University of Glasgow (UofG) and Wave-1 Urban 5G use case implementation lead at Glasgow 5G Testbed funded by the Scotland 5G Center. His research interests include wireless communications, intelligent transport systems, terrestrial/airborne mobile networks, healthcare and cloud networking technologies.



Patrick Langdon Professor Patrick Langdon is a Professor of Engineering Design, Transportation, and Inclusion at Edinburgh NAPIER School of Engineering and the Built Environment (SEBE). He is an Experimental Psychologist and has worked in AI, Robotics and Engineering Design for over 20 Years. Historically he has led research in Inclusive Design and contributed to its literature. His current research concerns the application of Cognitive science and AI to multidisciplinary areas of research such as the design, use and provision for Autonomous vehicles in current transportation planning. Multidisciplinary research centred on Engineering is a key theme in his research and his goal is to foster new programmes of research in this area.



Ian J. Wassell received the B.Sc. and B.Eng. degrees from the University of Loughborough, Loughborough, U.K., in 1983, and the Ph.D. degree from the University of Southampton, Loughborough, U.K., in 1990. He is a Senior Lecturer with the University of Cambridge Computer Laboratory and has in excess of 15 years experience in the simulation and design of radio communication systems gained via a number of positions in industry and higher education. He has authored or coauthored more than 180 papers concerning wireless communication systems. His current research interests include fixed wireless access, sensor networks, cooperative networks, propagation modelling, compressive sensing, and cognitive radio. He is a member of the IET and a Chartered Engineer.



Qammer Abbasi (SM'16) received the B.Sc. and M.Sc. degrees in electronics and telecommunication engineering from the University of Engineering and Technology (UET), Lahore, Pakistan, and the Ph.D. degree in electronic and electrical engineering from the Queen Mary University of London (QMUL), U.K., in 2012. He is currently a Lecturer (Assistant Professor) with the James Watt School of Engineering, University of Glasgow, U.K. and research investigator with Scotland 5G Center. He has received several recognitions for his research, which include appearance on BBC, STV, local and international newspapers, most downloaded articles, U.K. exceptional talent endorsement by Royal Academy of Engineering, National Talent Pool Award by Pakistan, International Young Scientist Award by NSFC China, URSI Young Scientist Award, National Interest Waiver by USA, four best paper awards, and best representative image of an outcome by QNRF. He is an Associate Editor for the IEEE JOURNAL OF ELECTROMAGNETICS, RF AND MICROWAVES IN MEDICINE AND BIOLOGY, the IEEE SENSORS JOURNAL, IEEE OPEN ACCESS ANTENNA AND PROPAGATION, IEEE ACCESS and acted as a guest editor for numerous special issues in top notch journals.



Muhammad Imran (M'03–SM'12) received the M.Sc. (Hons.) and Ph.D. degrees from Imperial College London, U.K., in 2002 and 2007, respectively. He is Dean Glasgow College UESTC and a Professor of communication systems with the James Watt School of Engineering, University of Glasgow, U.K. He is an Affiliate Professor at the University of Oklahoma, USA, and a Visiting Professor at the 5G Innovation Centre, University of Surrey, U.K. He is leading research in University of Glasgow for Scotland 5G Center. He has over 18 years of combined academic and industry experience, working primarily in the research areas of cellular communication systems. He has been awarded 15 patents, has authored/co-authored over 400 journal and conference publications, and has been principal/co-principal investigator on over £6 million in sponsored research grants and contracts. He has supervised 40+ successful Ph.D. graduates. He has an award of excellence in recognition of his academic achievements, conferred by the President of Pakistan. He was also awarded the IEEE Comsoc's Fred Ellersick Award 2014, the FEPS Learning and Teaching Award 2014, and the Sentinel of Science Award 2016. He was twice nominated for the Tony Jean's Inspirational Teaching Award.



Simeon Keates received the M.A. and Ph.D. degrees in engineering from the Department of Engineering, University of Cambridge, Cambridge, U.K. He is currently the Deputy Vice-Chancellor (DVC) of the University of Chichester. Prior to Chichester, Simeon was the dean of the School of Engineering and the Built Environment at Edinburgh Napier University and former Deputy Pro Vice-Chancellor of the Faculty of Engineering and Science at the University of Greenwich. He was previously Chair of HCI and Head of School of Engineering, Computing and Applied Mathematics at the University of Abertay Dundee and Associate Professor at the IT University of Copenhagen. He obtained his PhD from the University of Cambridge, where he also worked as an Industrial Research Fellow in the Engineering Design Centre. After 12 years at Cambridge, he moved to the US and joined the Accessibility Research Group at the IBM TJ Watson Research Center before moving to Boston and working at ITA Software (now part of Google) designing airport systems for Air Canada.